

# Table of Contents

<b>1. Introduction</b>	5
Step 1 - Upgrade manual info	6
Step 2 - Preparing the upgrade kit	6
Step 3 - What will be upgraded?	7
Step 4 - Getting the necessary tools	8
Step 5 - Labels guide	8
Step 6 - Printed parts - versioning	9
Step 7 - We are here for you!	9
Step 8 - Pro tip: inserting the nuts	10
Step 9 - View high resolution images	10
Step 10 - Important: Electronics protection	11
Step 11 - How to successfully finish the assembly	12
Step 12 - Prepare your desk	13
Step 13 - Parts no longer needed	13
Step 14 - Cleaning the hotend	14
Step 15 - Reward yourself	15
Step 16 - Preparing the printer	15
Step 17 - MMU3 preparation	16
Step 18 - Additional Information	16
<b>2. Upgrading the Y-axis</b>	17
Step 1 - Y-axis parts info	18
Step 2 - Tools necessary for this chapter	18
Step 3 - Preparing the printer	19
Step 4 - Removing the Y-belt-tensioner	19
Step 5 - Removing the Y-belt-holder	20
Step 6 - New Y-belt mounting: parts preparation	20
Step 7 - Assembling the Y-belt-holder	21
Step 8 - Assembling the Y belt	21
Step 9 - Attaching the Y belt holder	22
Step 10 - Assembling the Y belt tensioner	22
Step 11 - Attaching the Y belt tensioner	23
Step 12 - Tensioning the Y belt	23
Step 13 - Belt tension check	24
Step 14 - What's left...	24
Step 15 - Haribo time!	25
Step 16 - Done	25
<b>3. Upgrading the xLCD</b>	26
Step 1 - Tools necessary for this chapter	27
Step 2 - Removing the xLCD assembly	27
Step 3 - Disassembling the xLCD	28
Step 4 - MK4: xLCD versions	29
Step 5 - xLCD A: parts preparation (part 1)	29
Step 6 - xLCD A: parts preparation (part 2)	30
Step 7 - Installing the xReflector sticker (xLCD A)	30
Step 8 - Covering the xLCD (xLCD A)	31
Step 9 - Installing the PE Faston (xLCD A)	31
Step 10 - Attaching the knob (xLCD A)	32
Step 11 - Connecting the assembly (xLCD A)	32
Step 12 - Mounting the assembly (xLCD A)	33
Step 13 - What's left... (xLCD A)	33

Step 14 - xLCD B .....	34
Step 15 - xLCD B: parts preparation (part 1) .....	34
Step 16 - xLCD B: parts preparation (part 2) .....	35
Step 17 - Installing the xReflector sticker (xLCD B) .....	35
Step 18 - Installing the M3n nut (xLCD B) .....	36
Step 19 - xLCD-support assembly (xLCD B) .....	36
Step 20 - xLCD-support-left assembly (xLCD B) .....	37
Step 21 - Attaching the knob (xLCD B) .....	37
Step 22 - Connecting the assembly (xLCD B) .....	38
Step 23 - Attaching the assembly (xLCD B) .....	38
Step 24 - Haribo time! .....	39
Step 25 - Well... .....	39
<b>4. Upgrading the Nextruder .....</b>	<b>40</b>
Step 1 - MK4S MMU3 .....	41
Step 2 - Tools necessary for this chapter .....	41
Step 3 - Protecting the heatbed .....	42
Step 4 - Uncovering the Nextruder .....	42
Step 5 - Removing the idler-swivel .....	43
Step 6 - Assembling the Idler-swivel: parts preparation .....	44
Step 7 - Assembling the Idler-swivel .....	44
Step 8 - Assembling the Idler-nut .....	45
Step 9 - Disconnecting the Nextruder cables .....	45
Step 10 - Removing the print fan assembly .....	46
Step 11 - Removing the heatsink fan&hotend .....	46
Step 12 - Removing the Nextruder .....	47
Step 13 - Gearbox versions .....	48
Step 14 - Uncovering the gearbox .....	49
Step 15 - Removing the extruder idler .....	49
Step 16 - Extruder idler assembly: parts preparation .....	50
Step 17 - Upgrading the extruder idler .....	50
Step 18 - PG-cover: parts preparation .....	51
Step 19 - Installing the idler and PG-cover .....	52
Step 20 - Mounting the idler-swivel: parts preparation .....	52
Step 21 - Mounting the Idler-swivel assembly .....	53
Step 22 - Assembling the Nextruder: parts preparation .....	53
Step 23 - Assembling the Nextruder .....	54
Step 24 - Attaching the Nextruder .....	54
Step 25 - Connecting the NTC thermistor .....	55
Step 26 - Assembling the hotend fan: parts preparation .....	55
Step 27 - Assembling the hotend fan .....	56
Step 28 - Print fan blower: parts preparation .....	56
Step 29 - Assembling the print fan case .....	57
Step 30 - Assembling the print fan blower .....	57
Step 31 - Assembling the fan shroud .....	58
Step 32 - Mounting the print fan blower assembly .....	58
Step 33 - Connecting the print fan blower .....	59
Step 34 - Prusa Nozzle CHT: parts preparation .....	59
Step 35 - Removing the Prusa Nozzle .....	60
Step 36 - Installing the Prusa Nozzle CHT .....	60
Step 37 - Inserting the hotend assembly: parts preparation .....	61
Step 38 - Inserting the hotend assembly .....	61
Step 39 - Nozzle insertion check .....	62
Step 40 - Connecting the hotend cables .....	62
Step 41 - Fan door cover: parts preparation .....	63

Step 42 - Attaching the Fan-door-cover .....	63
Step 43 - Connecting the extruder cables .....	64
Step 44 - LoveBoard: Wiring check .....	64
Step 45 - Covering the LoveBoard: parts preparation .....	65
Step 46 - Covering the LoveBoard: side cover .....	65
Step 47 - Covering the LoveBoard: top cover .....	66
Step 48 - What's left (part 1) .....	66
Step 49 - What's left (part 2) .....	67
Step 50 - Haribo time! .....	67
Step 51 - The Nextruder is upgraded! .....	68
<b>4B. Upgrading the Nextruder (MMU3) .....</b>	<b>69</b>
Step 1 - Tools necessary for this chapter .....	70
Step 2 - Protecting the heatbed .....	70
Step 3 - Uncovering the Nextruder .....	71
Step 4 - Disconnecting the Nextruder cables .....	71
Step 5 - Removing the print fan assembly .....	72
Step 6 - Removing the heatsink fan&hotend .....	72
Step 7 - Removing the Nextruder .....	73
Step 8 - Uncovering the gearbox .....	74
Step 9 - PG-case: parts preparation .....	75
Step 10 - Installing the new PG-case .....	75
Step 11 - Assembling the Nextruder: parts preparation .....	76
Step 12 - Assembling the Nextruder .....	76
Step 13 - Attaching the Nextruder .....	77
Step 14 - Connecting the NTC thermistor .....	77
Step 15 - Assembling the hotend fan: parts preparation .....	78
Step 16 - Assembling the hotend fan .....	78
Step 17 - Print fan blower: parts preparation .....	79
Step 18 - Assembling the print fan case .....	79
Step 19 - Assembling the print fan blower .....	80
Step 20 - Assembling the fan shroud .....	80
Step 21 - Mounting the print fan blower assembly .....	81
Step 22 - Connecting the print fan blower .....	81
Step 23 - Prusa Nozzle info .....	82
Step 24 - Inserting the hotend assembly: parts preparation .....	82
Step 25 - Inserting the hotend assembly .....	83
Step 26 - Nozzle insertion check .....	83
Step 27 - Connecting the hotend cables .....	84
Step 28 - Fan door cover: parts preparation .....	84
Step 29 - Attaching the Fan-door-cover .....	85
Step 30 - Connecting the extruder cables .....	85
Step 31 - LoveBoard: Wiring check .....	86
Step 32 - Covering the LoveBoard: parts preparation .....	86
Step 33 - Covering the LoveBoard: side cover .....	87
Step 34 - Covering the LoveBoard: top cover .....	87
Step 35 - The Nextruder is upgraded! .....	88
Step 36 - Attaching the MMU3 unit .....	88
Step 37 - Connecting the MMU3 unit .....	89
Step 38 - Haribo Zeit! .....	89
<b>5. Upgrading the connectivity .....</b>	<b>90</b>
Step 1 - Tools necessary for this chapter .....	91
Step 2 - Opening the electronics .....	91
Step 3 - Removing the Wi-Fi&heatbed covers .....	92
Step 4 - Wi-Fi: parts preparation .....	92

Step 5 - Assembling the Wi-Fi .....	93
Step 6 - Installing the WiFi cover assembly .....	93
Step 7 - NFC antenna: parts preparation I. ....	94
Step 8 - NFC antenna: parts preparation II. ....	94
Step 9 - Installing the NFCcoil (pre-assembled) .....	95
Step 10 - Connecting the NFC antenna .....	96
Step 11 - Preparing the NFCcoil .....	96
Step 12 - Assembling the NFC antenna .....	97
Step 13 - Verify all connections once more! .....	97
Step 14 - Covering the xBuddy box: bottom cover .....	98
Step 15 - Covering the xBuddy box .....	98
Step 16 - Serial number label: parts preparation .....	99
Step 17 - Sticking the serial number label .....	99
Step 18 - What's left... ..	100
Step 19 - Haribo time! .....	100
Step 20 - That's it! .....	101
<b>6. Preflight check .....</b>	<b>102</b>
Step 1 - Attaching the print sheet .....	103
Step 2 - Firmware updating .....	103
Step 3 - First run .....	104
Step 4 - Printer setup .....	104
Step 5 - Wizard - Selftest start .....	105
Step 6 - Wizard - Loadcell Test .....	106
Step 7 - Wizard - Gearbox Alignment .....	106
Step 8 - Wizard - Filament Sensor Calibration .....	107
Step 9 - Haribo time! .....	107
Step 10 - Loading a filament .....	108
Step 11 - Printable 3D models .....	108
Step 12 - Network setup: Prusa Connect (Optional) .....	109
Step 13 - PrusaSlicer .....	110
Step 14 - Quick guide for your first prints .....	110
Step 15 - Prusa knowledge base .....	111
Step 16 - Join Printables! .....	111
<b>Manual changelog .....</b>	<b>112</b>
Step 1 - Version history .....	113
Step 2 - Changes to the manual (1) .....	113

# 1. Introduction



## STEP 1 Upgrade manual info



**i** This manual guides you through upgrading your Original Prusa **MK4 to MK4S** or **MK3.9 to MK3.9S**, with all instructions applying to both upgrades.

**!** **NOTE:** The provided pictures feature the MK4S, so you may notice MK4S logos across the manual.

## STEP 2 Preparing the upgrade kit



**◆** Please prepare the upgrade kit received from Prusa Research.

**i** **MMU3:** This manual also includes instructions for MMU3 owners. These instructions are separated and indicated in advance.

## STEP 3 What will be upgraded?

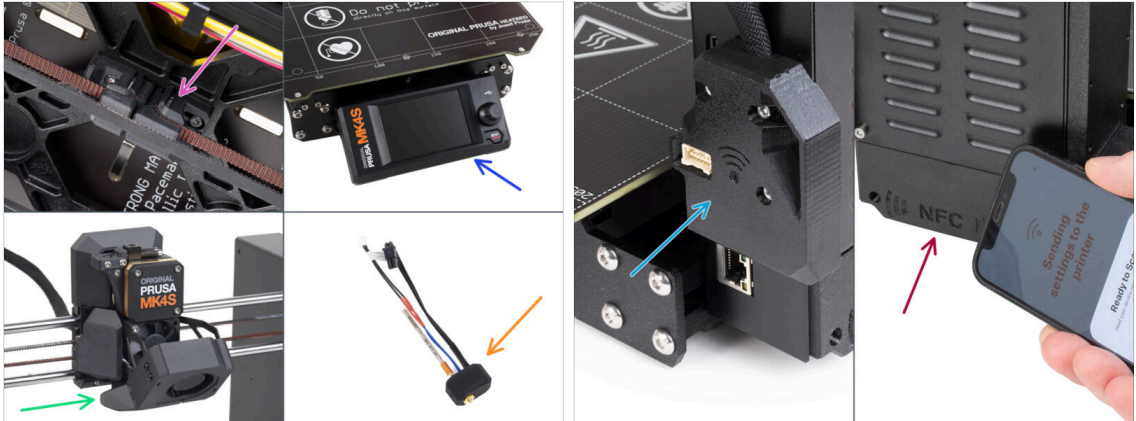

- **MK4/MK3.9 upgrade to MK4S/MK3.9S includes changes to:**
- New Y-axis tensioning mechanism printed from PCCF material for greater heat resistance.
- New injection molded xLCD cover.
  - ⓘ It is compatible with certain xLCD board versions. In case of incompatibility, a new printed cover will be provided—more information is in the relevant chapter of the manual.
- New 360° cooling on the Nextruder.
- New high-flow Prusa Nozzle CHT.
- Improved Wi-Fi antenna.
- Brand new NFC antenna.

## STEP 4 Getting the necessary tools

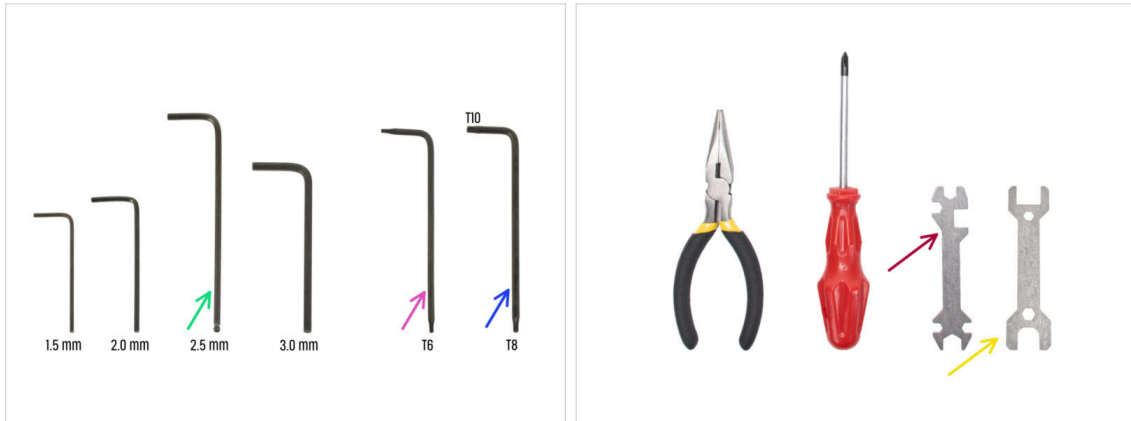

- Use the tools that came with your MK4/MK3.9 printer.
- **For this upgrade you will need:**
  - 2.5mm Allen key
  - Torx key T6
  - Torx key T10/8
  - Wrench 13-16
  - Universal wrench
  - Brass brush *for cleaning the hotend*

## STEP 5 Labels guide



- All the boxes and bags including parts for the build are labeled.
- The labels include the list of contents and part count.
- You can download a **Cheatsheet** with 1:1 fastener drawings from our site [prusa.io/cheatsheet-mk4s](https://prusa.io/cheatsheet-mk4s). Print it at 100 %, don't rescale it, otherwise, it won't work.
- ⓘ For PRUSA veterans: Fasteners are divided into individual bags according to its type. Not into packages for individual chapters, as it was with previous printers.



## STEP 6 Printed parts - versioning



- ◆ Most of the 3D printed parts are marked with their version.
- ◆ **E, F and Gx series** (e.g. E1) - those parts are printed on Prusa Research farm and are distributed with the kit.
- ◆ **R, S and Tx series** (e.g. R1) - those parts are available for download at [prusa.io/printable-parts-mk4s](https://prusa.io/printable-parts-mk4s). They are identical to the factory ones.
- ⓘ In case you have issues while assembling the printer with the certain printed part, please try to find this label and tell it to our support team.

## STEP 7 We are here for you!

**Step 13** Assembling the Nextruder idler

Insert the idler assembly between the PG-ring and the extruder motor. There is a cutout for the spacer in the main plate. Line up the idler spacer with the hole in the PG-ring.

Secure both parts with grub screw 3x25. Do not overtighten the screw! The grub screw protrudes from the PG-ring after tightening.

Apply a small amount of Prusa Lubricant all around the PG-ring and PG-assembly teeth.

Tip: apply a small amount of lubricant to the tip of the zip tie and then spread the lubricant over the gears.

Using a paper towel, wipe off any excess lubricant on the front surfaces.

2 comments

Add comment

**B I ⌘ I**

Write your comment here...

POWERED BY TINY

SUBMIT

Secure both parts with grub screw 3x25. Do not overtighten the screw! The grub screw protrudes from the PG-ring after tightening.

Apply a small amount of Prusa Lubricant all around the PG-ring and PG-assembly teeth.

Tip: apply a small amount of lubricant to the tip of the zip tie and then spread the lubricant over the gears.

Using a paper towel, wipe off any excess lubricant on the front surfaces.

2 comments

POWERED BY TINY

SUBMIT

Chat now

- ◆ Lost in the instructions, missing screw or cracked printed part? **Let us know!**
- ◆ You can contact us using the following channels:
  - ◆ Using comments under each step.
  - ◆ Using our 24/7 live chat here at [help.prusa3d.com](https://help.prusa3d.com)
  - ◆ Writing an email to [info@prusa3d.com](mailto:info@prusa3d.com)

## STEP 8 Pro tip: inserting the nuts



- ◆ 3D printed parts are very precise, however, there still might be a tolerance in the printed part and the same goes for the size of the nut.
- ◆ Therefore it might happen, that the nut won't fit easily in or might be falling out. Let's see, how to fix it:
  - ◆ **Nut won't fit in:** use a screw with a thread along its entire length (typically: M3x10, M3x18) and screw it from the opposite side of the opening. While tightening the screw, the nut will be pulled in. Remove the screw afterwards.
  - ◆ **Alternative option:** you can use X-holder tool included in the package. Insert any screw (typically: M3x10 or M3x18) and screw the nut fully on the tip of the thread. Push the nut into the printed part and remove the screw with X-holder.
  - ◆ **Nut keeps falling out:** Use a piece of tape to fix the nut temporarily in place, as soon as you insert the screw in, you can remove the tape. Using glue isn't recommended as it can partly reach into the thread and you won't be able to tighten the screw properly.
- ◆ Every time we recommend using the "screw pulling technique", you will be reminded with Joe's avatar ;)
- (i) Parts in the pictures are used as an example.

## STEP 9 View high resolution images



- ◆ When you browse the guide on [help.prusa3d.com](https://help.prusa3d.com), you can view the original images in high resolution for clarity.
- ◆ Just hover your cursor over the image and click the Magnifier button ("View original") in the top left corner.

## STEP 10 Important: Electronics protection

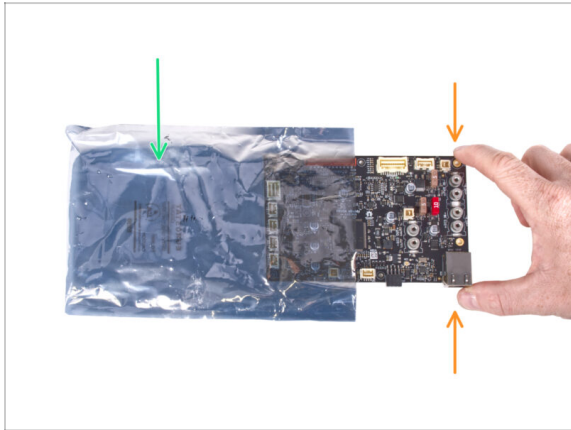

**⚠ WARNING:** Make sure to **protect the electronics against electrostatic discharge (ESD)**. Always unpack the electronics right before you need them!

Here are some **tips to prevent damage to the electronics:**

- **Keep the electronics inside the ESD bag** right until you are asked to install them.
- **Always touch the sides of the board only** while handling it. Avoid touching the components on the surface.
- **Before you touch the electronics** use any conductive (metal) structure nearby to neutralize the possible static charge from your hands.
- Be extra cautious **in rooms with carpets**, which are often a source of electrostatic energy.
- Clothes made of wool or certain synthetic fabrics can easily gather static electricity too. It is safer to wear cotton clothing for the assembly.

## STEP 11 How to successfully finish the assembly

**Step 25** Attaching the spacers



- Insert two M3n nuts to the X-carriage-back.
- ⌚ Use the screw pulling technique.
- From the opposite side, insert the M3x10 screw into the X-carriage-back. The screw must protrude from the "front" side of the part.
- Attach the spacer 10 mm on the M3x10 screw and tighten the screw. **Note the cutout of the same shape as the spacer. It must fit perfectly and must not rotate.**



2 comments

 **To successfully finish the upgrade please follow all these:**

- ◆ **Always read all the instructions at the current step first**, it will help you to understand what you need to do. Don't cut or trim unless you are told to!!!
- ◆ **Don't follow pictures only!** It is not enough, the written instructions are as brief as they could be. **Read them!**
- ◆ Read the comments from the other users, they are a great source of ideas. We read them too and based on your feedback improve the manual and the entire assembly.
- ◆ **Use a reasonable force**, the printed parts are tough, but not unbreakable. If it doesn't fit, check your approach twice.
- ◆ **Most important: Enjoy the build, have fun.** Cooperate with your kids, friends or partners.

## STEP 12 Prepare your desk



- ◆ Tidy up your desk! Tidying up decreases the probability of losing small parts.
- ◆ **Clear your workspace.** Make sure you have enough room. A nice clear flat workbench will get you the results you are aiming for.
- ◆ **Let there be light!** Make sure you are in a well-lit environment. Another lamp or even an extra flashlight will probably come in handy.
- ◆ Prepare something to contain the plastic bags and the removed packing materials so you can recycle them afterwards. Make sure there are no important parts being discarded.

## STEP 13 Parts no longer needed



- ◆ Certain parts will no longer be needed for this upgrade. A list of these parts is provided at the end of each chapter.
- 📌 Keep all parts until you complete the chapter, then discard the unnecessary items according to the list provided at the end of that chapter.
- ⓘ Tip: You can repurpose any removed electronic parts for your future projects.
- ◆ You may also have leftover fasteners, with the quantity varying depending on your MK4 version.
- ⚠️ **CAUTION: Always compare the new parts with the provided pictures to avoid confusing them with the old parts.**
- ⓘ NOTE: For visually similar parts, we will always notify you when new parts are involved.

## STEP 14 Cleaning the hotend

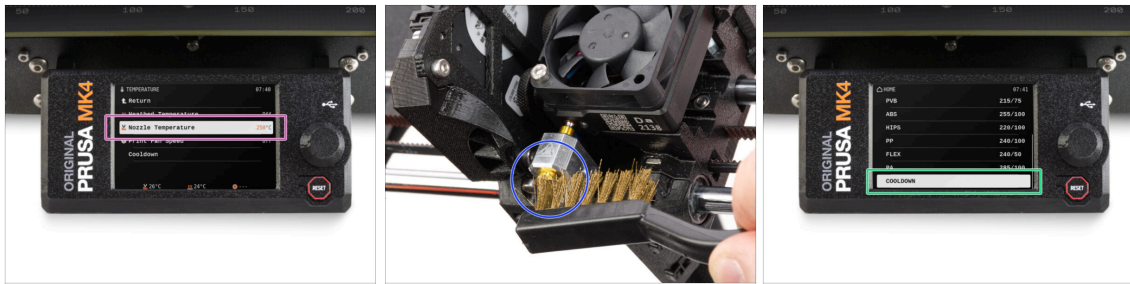

**⚠ WARNING: The hotend and heatbed are very HOT. Do not touch these parts!!!**

⬛ The upgrade includes a replacement CHT nozzle. Ensure the hotend is clean before the exchange, as a dirty hotend can make it difficult to remove the installed nozzle.

**⚠ If you have a Prusa hotend sock on the hotend, remove it.**

🟡 On the printer screen, go to *Control* -> *Temperature* -> *Nozzle Temperature* and using the knob set **250°C**.

⬛ Wait at least 5 minutes. The remains of the filament must be warmed up slightly so that they can be removed more easily.

🟡 Using the brass brush, carefully clean the heaterblock and the hotend from the filament residue. **Avoid contact of the brush with the hotend cables, as this could cause a short circuit.**

🟢 When the heaterblock and the hotend are perfectly clean, cool down the printer. On the screen, navigate to *Preheat* -> *Cooldown*.

**⚠ Wait until the hot parts are cooled down to ambient temperature. It takes approximately 10 minutes.**

## STEP 15 Reward yourself



- ◆ Based on the feedback, building the MK4S/MK3.9S printer is even more enjoyable compared to the MK4. However, you should still treat yourself for every finished chapter. Look in the box and find a bag of Haribo Bears.
- ⚠ **The biggest issue from our experience (MK4, MK3S+, MK3S, MK3, MK2S, ...) is inadequate bear consumption. Many of you didn't have enough gummy bears for all chapters, some even ate them all before they started!**
- ◆ After years of thorough scientific research, we came to a solution => At the end of each chapter, you will be told a specific amount of bears to consume.
- ◆ Eating an incorrect amount than prescribed in the manual might lead to a sudden boost of energy. Please consult a professional in the closest candy store.
- ⚠ **Hide the Haribo for now! From our experience, an unattended bag with sweets will suddenly disappear. Confirmed by multiple cases all around the World.**

## STEP 16 Preparing the printer

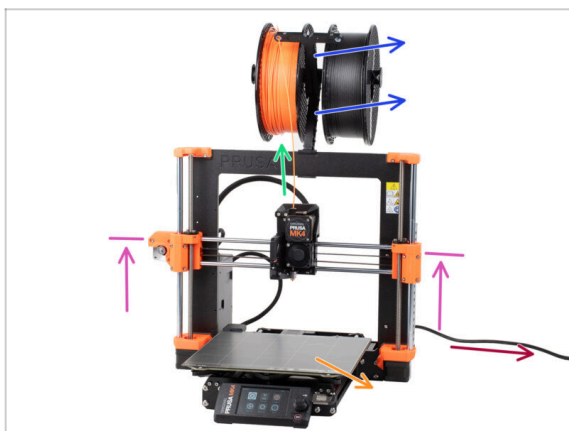



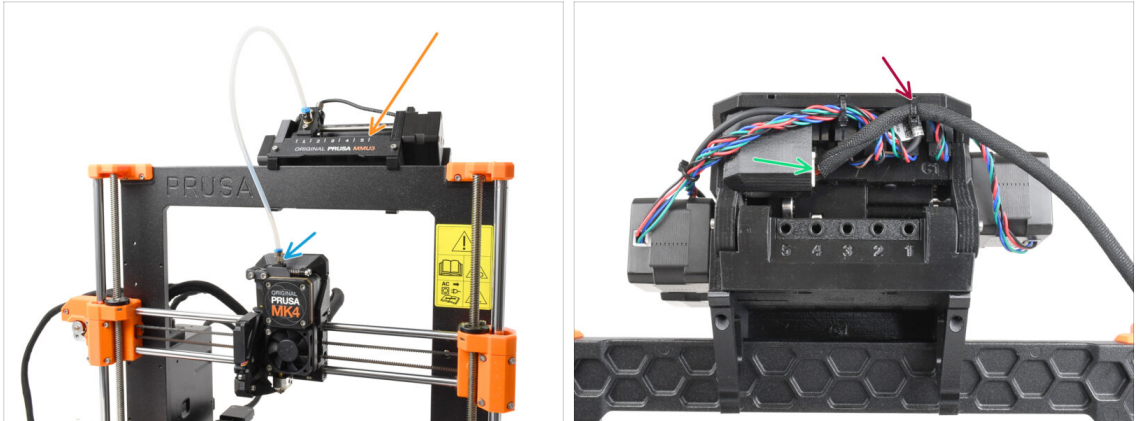

- ⚠ **Before you start with upgrading your printer, do the following:**
  - ◆ Unload filament from the printer.
  - ◆ Take off the spool holder.
  - ◆ Remove the print sheet.
  - ◆ Move the X-axis to the center of the Z-axis.
- ⚠ **Turn the printer OFF and unplug the power cord.**
- ◆ Remove the USB stick from the printer.

## STEP 17 MMU3 preparation





 This step is only for the MK4/MK3.9 + MMU3 users!

-  Disconnect the PTFE tube fitting from the Nextruder.
-  Remove the MMU3 unit from the printer and set it aside. We will re-install it later on.
-  Carefully cut off the zip-tie holding the MMU-Printer cable on the MMU unit.
-  Disconnect the cable from the MMU unit.

## STEP 18 Additional Information



-  This information applies to users planning to install accessories, such as the Original Prusa Enclosure, or upgrades like the MMU3.
  -  Before installing any accessories, it's essential to **assemble and test your printer according to the instructions**. Once the printer is fully functional, follow the separate MMU3 or Enclosure assembly manual to modify the printer for installation.



## 2. Upgrading the Y-axis



## STEP 1 Y-axis parts info

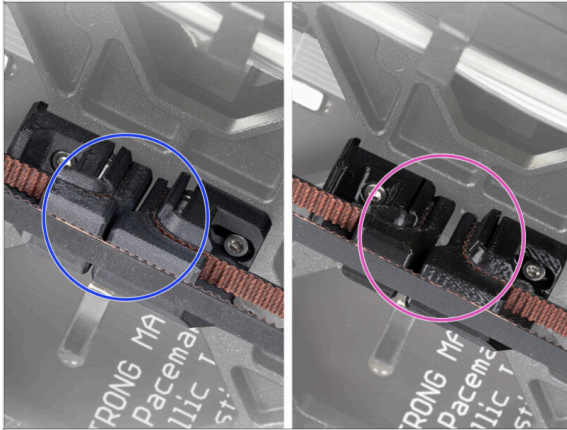

**i** In this chapter, you will upgrade the old Y-axis belt tension mechanism with new parts printed from PCCF material.

⬢ The latest MK4 units might already include Y-axis parts upgraded to PCCF. If your printer has these, you can skip this chapter.

⬢ **To verify, take a closer look from the underside of the Y-carriage and inspect the parts:**

⬢ **New Y-axis parts:** PCCF has a dull, slightly grayish texture

⬢ **Old Y-axis parts:** PETG is glossy black

**⚠ Ensure you thoroughly check before skipping.**

## STEP 2 Tools necessary for this chapter



⬢ **For this chapter, please prepare:**

⬢ 2.5mm Allen key

### STEP 3 Preparing the printer

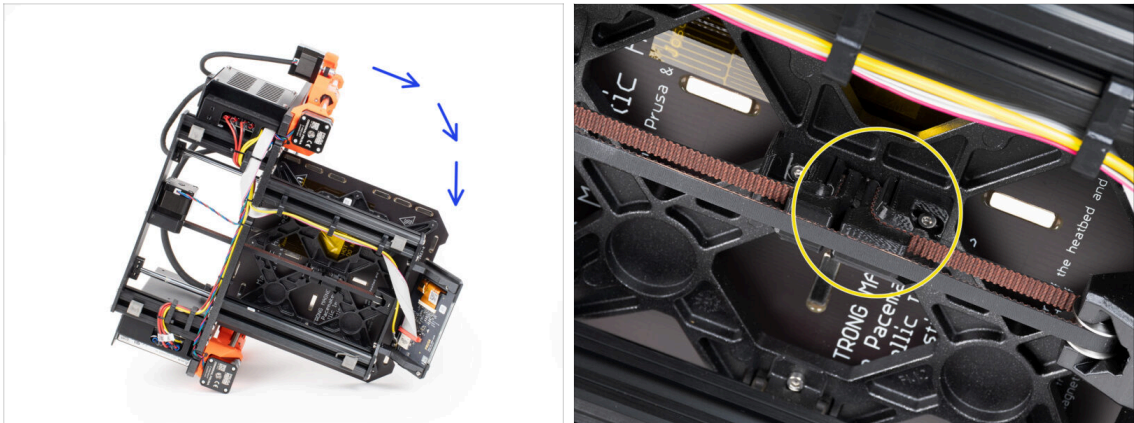

- ◆ Lean the printer onto the right side (the one with the PSU) to gain access to the bottom.
- Take a look at the Y-axis from the underside and locate the Y-belt-tensioner.

### STEP 4 Removing the Y-belt-tensioner

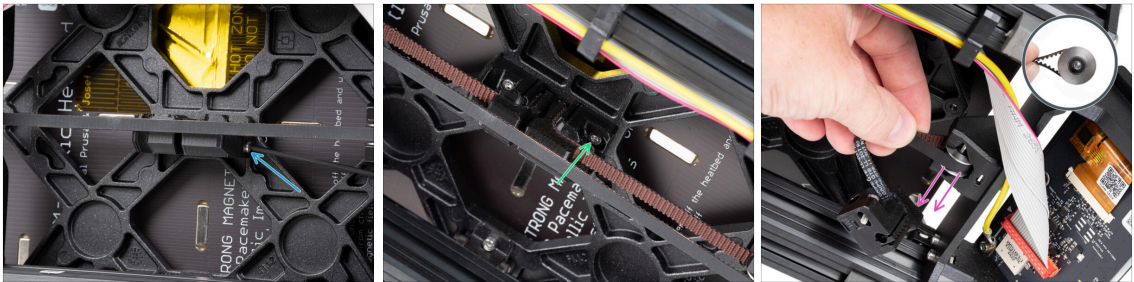

- ◆ From the front side of the Y-belt-tensioner, completely remove the M3x40 screw.
  - ⓘ Tip: The loose screw can be pulled out with pliers.
- ◆ Release and remove the M3x10 screw mounting the Y-belt-tensioner to the Y-carriage.
- ◆ Remove the belt with the GT2-20 pulley from the Y-belt idler, and then take it out of the printer.
- ⚠ **Be careful not to lose the pin from the pulley. You will need it again later on.**

## STEP 5 Removing the Y-belt-holder

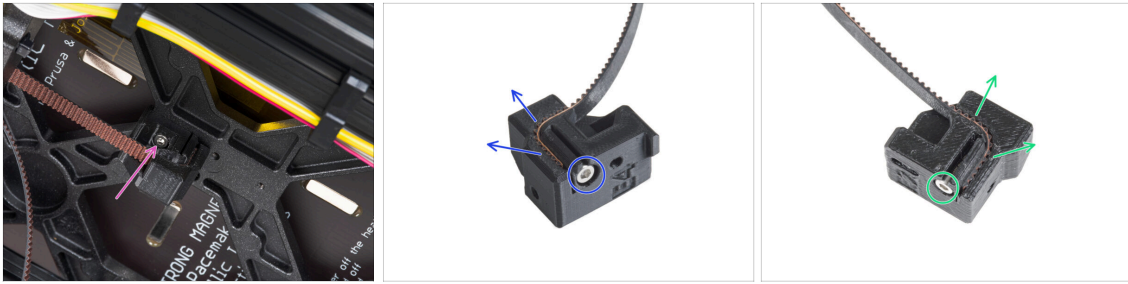

- ◆ Release and remove the M3x10 screw mounting the Y-belt-holder to the Y-carriage and remove it from the printer.
- ◆ Release and remove the M3x10 screw from the Y-belt-holder and remove the belt from the part.
- ◆ Release and remove the M3x10 screw from the Y-belt-tensioner and remove the belt from the part.
- ⓘ Some early units may have the Y-belt tensioner and Y-belt idler without the M3x10 screws for securing the belt.
- ⚠ **Keep the Y belt for the upgrade.**
- ◆ You will no longer need the Y-belt-holder and Y-belt-tensioner.

## STEP 6 New Y-belt mounting: parts preparation



- ◆ **For the following steps, please prepare:**
- ◆ New Y-belt-tensioner (1x) *with an oval hole*
- ◆ New Y-belt-holder (1x) *with a hexagonal hole*
- ◆ Y belt (1x) *you removed earlier*
- ◆ M3nN nut (1x) *new one*
- ◆ M3x40 screw (1x) *you removed earlier*
- ◆ M3x10 screw (4x) *you removed earlier*
- ◆ GT2-20 pulley (1x) *you removed earlier*
- ◆ Pin H8 2.9x20 (1x) *you removed earlier*

## STEP 7 Assembling the Y-belt-holder



- ◆ Insert the M3nN nut into the Y-belt-holder using the screw pulling technique. **Ensure it is positioned as far as possible within the part.**

ⓘ Use the screw pulling technique. Attach the M3nN nut on the tip of the M3x40 screw (a few turns are enough). **Do not tighten the screw**, pull the nut all the way into the Y-belt-holder. Don't forget to remove the M3x40 screw from the part and keep it aside for later use.

## STEP 8 Assembling the Y belt

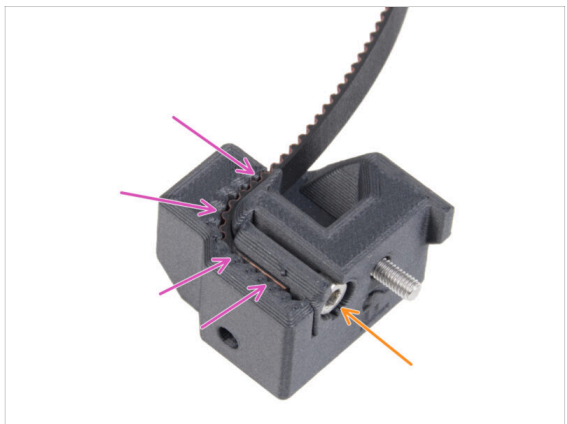

- Insert the M3x10 screw through the hole in the Y-belt-holder.
- Take one of the Y belt ends and push it into the Y-belt-holder. Note the orientation of the belt (teeth).
- Secure it by inserting and tightening one M3x10 screw.

## STEP 9 Attaching the Y belt holder

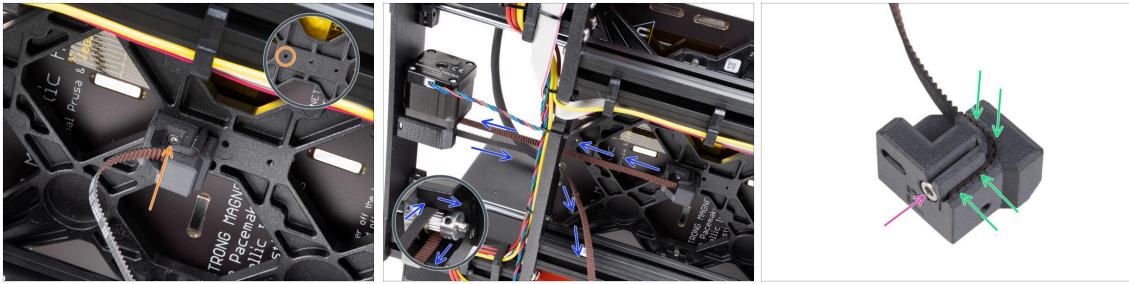

- Using the M3x10 screw, fix the Y-belt-holder to the Y-carriage. Use the left (rear) hole in the center part.
- ⓘ Tip: pre-screw the screw into the Y-belt-holder before attaching it to the Y-carriage.
- Guide the Y-axis belt around the Y-axis motor pulley. Make sure the belt is inside the frame, not under!
- Take the free end of the Y belt guiding from the pulley and push it into the groove in the Y-belt-tensioner.
- Secure it with the M3x10 screw.

## STEP 10 Assembling the Y belt tensioner

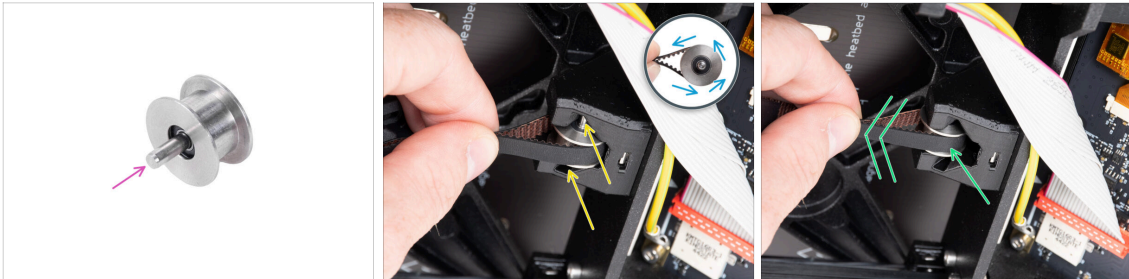

- Push the pin into the pulley and center it.
- Take the belt and guide it around the GT2-20 pulley.
- Insert the belt with the pulley into the Y-belt-idler on the rear of the front plate.
- Push the pulley all the way inside the printed part and lightly pull on the belt to lock the pulley in place.

## STEP 11 Attaching the Y belt tensioner

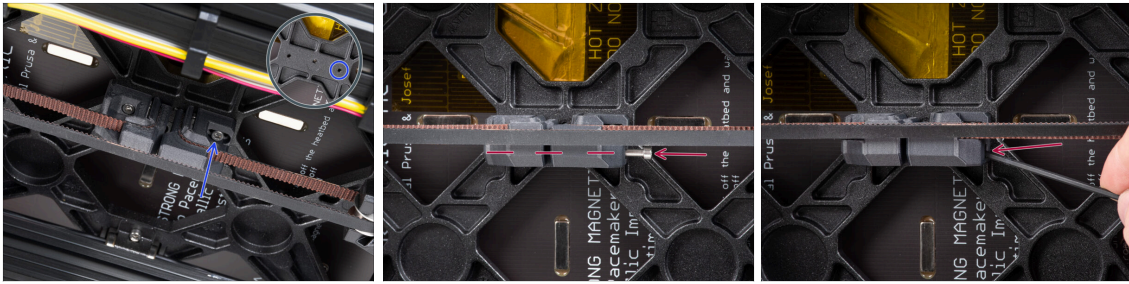

- ◆ Insert the M3x10 screw into the Y-belt-tensioner and try if the screw reaches the threaded hole in the Y-carriage when tensioning the belt.
  - i If the screw does not reach the hole, it is necessary to remove the Y-belt-holder (the one already installed) and reposition the belt by one tooth in both printed parts - one tooth in each printed part will be vacant. You must unscrew the M3x10 screw that securing the belt in the part.
- ◆ Attach the Y-belt-tensioner to the right (front) hole in the Y-carriage and secure it with the M3x10 screw. **Do not overtighten the screw.** We will adjust the exact position later on.
- ◆ Insert the M3x40 screw into the Y-belt-tensioner and tighten it until the screw reaches the nut in the second part.

## STEP 12 Tensioning the Y belt



- ◆ Move the Y-carriage all the way to the back. Using a finger on your left hand, push the belt down. A medium force should be needed to squish the belt until both the parts touch. Don't try to overstretch the belt as you might damage the printer.
- ◆ You can change the belt tension by adjusting the long M3x40 screw on the bottom of the Y-carriage.
  - ◆ **Tighten the screw** to bring the parts closer together and **increase the tension.**
  - ◆ **Release the screw** to move the parts apart to **decrease the tension.**
- ◆ After you set the correct belt tension, tighten up the M3x10 screw on the bottom to fix the Y-belt-tensioner in place.

### STEP 13 Belt tension check



- i This step is recommended, but optional. If you don't have a phone at your disposal, continue to the next step. You can do this check later on.
- ◆ To verify or fine-tune the X or Y-axis belt tension on your printer, visit [prusa.io/belt-tuner](https://prusa.io/belt-tuner) and open up the webpage on your mobile device. Or using your phone, scan the QR code in the picture.
- ◆ Watch the instructional video on [prusa.io/belt-tuner-video](https://prusa.io/belt-tuner-video) and fine-tune your Y belt tension, if required.
- i The belt tuner app was tested on multiple phones and should work across all most common phone manufacturers. However, in some rare cases it might not work as expected. Please state your brand and model in the comments below the step.

### STEP 14 What's left...



- ◆ At the end of each chapter, we'll show you which parts you have left. You will no longer need these parts:
  - ◆ Old Y-belt-holder (1x)
  - ◆ Old Y-belt-tensioner (1x)



### STEP 15 Haribo time!



**⚠** **Carefully and quietly** open the bag with the Haribo sweets. High level of **noise might attract nearby predators!**

- ◆ Arrange the bears in a similar pattern as in the picture.
- ◆ **Your package might contain fewer bears.** In such a case, run immediately to the nearest candy store! **The exact dosage is absolutely critical!!!**
- ◆ Eat one gummy bear. **I said just one!**

### STEP 16 Done



- ◆ You've successfully upgrade your Y-axis belt mounting system.
- ◆ Let's move to the next chapter **3. Upgrading the xLCD**

### 3. Upgrading the xLCD



## STEP 1 Tools necessary for this chapter

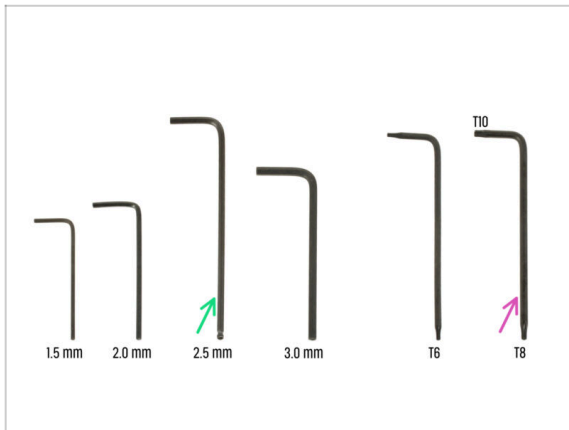

- For this chapter, please prepare:
- 2.5mm Allen key
- Torx key T8/10









## STEP 2 Removing the xLCD assembly



- Unscrew four M3x10 screws mounting the xLCD to the frame.
- Remove the xLCD from the frame. Put it in the front of the printer.
- ⚠ Do not pull on the xLCD cables!**
- Carefully pull of the PE Faston cable.
- i** The position of the PE Faston cable may vary depending on your xLCD version.  
Early units have the cable secured by a screw to the PE Faston connector.
- Carefully unplug the xLCD connector from the xLCD board.

## STEP 3 Disassembling the xLCD



-  **Make sure the USB drive is removed from the xLCD.**
-  Remove the knob from the xLCD assembly by simply pulling it off.
-  Release and remove all screws securing the xLCD board.
  -  **Do not discard the PE Faston connector (brass flat plate).**
-  Remove the xLCD-support-left (right from this view).
-  Carefully remove the xLCD board from the cover together with the xLCD-support-right.
  -  **Be careful not to damage the screen on the opposite side of the xLCD.**
-  Remove the xLCD-support-right from the xLCD.

## STEP 4 MK4: xLCD versions

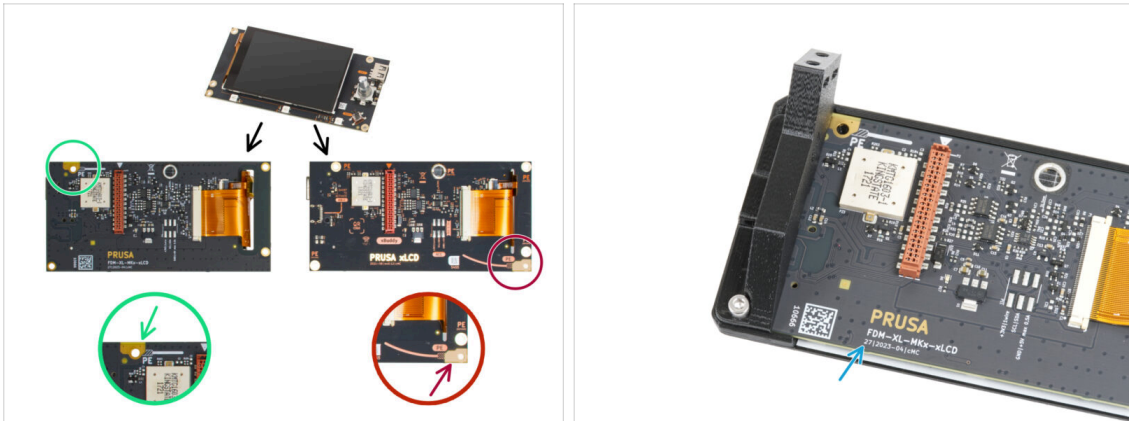

- **Find out which version of the xLCD you have.** It can be easily recognized by the location of the grounding connection (PE / FE) on the back of the PCB:
  - **The newer version A** - the grounding point is located on the top left hole.
    - ⌵ (version number 26, 27 and **higher**)
      - ⚠ **If you have this version, continue to the next step.**
  - **The older version B** - the grounding point (marked PE) is located on the bottom right hole.
    - ⌵ (rev. 0.12.2, 0.12.3 etc.)
      - ⚠ **If you have this version, continue to the xLCD B step.**
- The version numbers are printed on the PCB.

## STEP 5 xLCD A: parts preparation (part 1)

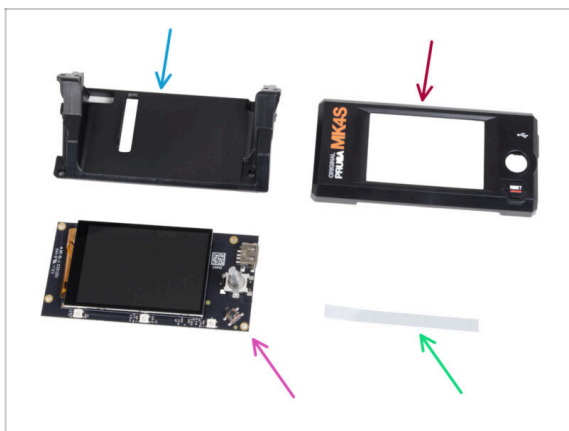

- **For the following steps, please prepare:**
  - xLCD-support(1x) *new part*
  - xLCD-cover (1x) *new part*
  - xLCD (1x) *you removed earlier*
  - xReflector sticker set (1x)
  - ⓘ The list continues in the next step...

## STEP 6 xLCD A: parts preparation (part 2)

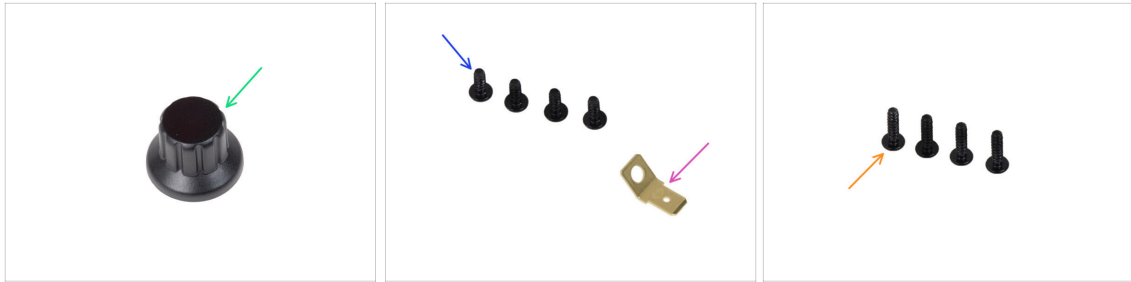

- ◆ xLCD-knob (1x) *new part*
- ◆ 3x8sT screw (4x)
- ◆ PE Faston 6.3x0.8 (1x) *you removed earlier*
- ◆ 3x12sT screw (4x)

## STEP 7 Installing the xReflector sticker (xLCD A)



- ◆ Peel off one of the individual adhesive xReflector sticker.
  - ◆ Note the separated part of the tape at one end. Do not peel off the remaining part.
- ⓘ If the sticker is damaged during peeling, there is an extra sticker in the SPARE package.
- ◆ Position the xReflector sticker strip so that it lines up with one side and both the edges of the "gutter" in the xLCD-cover. Continue to lay down the xReflector sticker strip towards the other side of the gutter.
- ◆ Press the xReflector sticker strip all the way into the gutter so it adheres to the xlcd-cover.

### STEP 8 Covering the xLCD (xLCD A)



- Carefully slide the xLCD into the xLCD-support, ensuring it snaps under the plastic tabs. Align the screw holes in the xLCD board with the holes in the plastic part.
- Place the xLCD-cover on the xLCD, orienting it so the encoder passes through the hole in the cover.

### STEP 9 Installing the PE Faston (xLCD A)



- From the back of the xLCD assembly, secure all parts together using three 3x8sT.
  - ⓘ The screws cut thread directly into the plastic, so there might be some resistance.
- Through the opening in the xLCD-support, place the PE Faston on the xLCD with the exact orientation as shown.
- Center the PE Faston in the opening and secure it with the 3x8sT screw.
  - ⓘ The screw cuts thread directly into the plastic, so there might be some resistance.

## STEP 10 Attaching the knob (xLCD A)



- Attach and push the xLCD-knob onto the xLCD encoder pin.
- ⓘ Note that there is a flat part on the encoder shaft. There is a geometry on the inside of the knob that should align with the flat part to seat the knob properly.

## STEP 11 Connecting the assembly (xLCD A)



- Connect the xLCD cable to the xLCD board. **Ensure the safety latch of the xLCD cable connector is up.**
- ⚠ Make sure the xLCD cable is connected in the same orientation as seen in the picture. Otherwise, your display won't work
- ◆ Slide the connector onto the PE Faston all the way.



## STEP 12 Mounting the assembly (xLCD A)

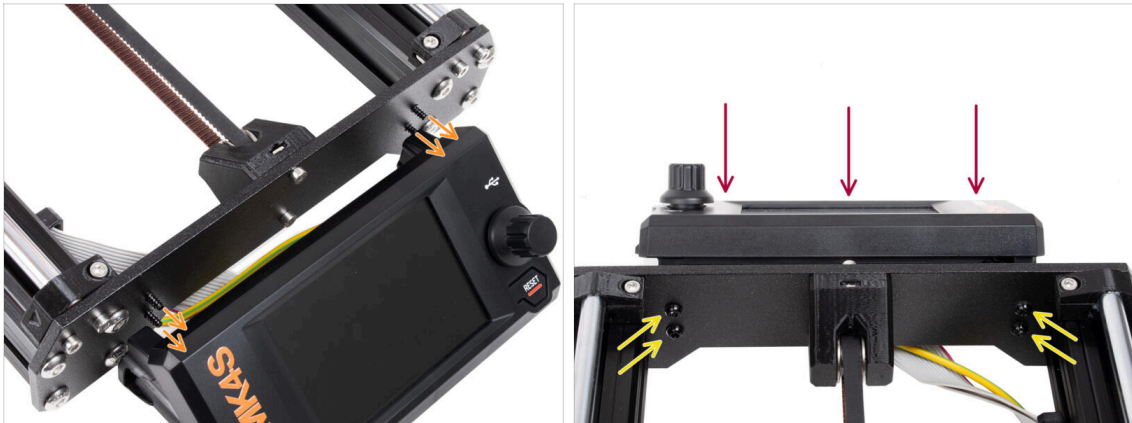

- There are four holes in the front plate of the printer's frame. Insert four 3x12sT screws through each of them from the inner side.
  - Attach the xLCD assembly onto the front plate. The screws should fit into the corresponding openings in the xLCD assembly.
  - Tighten up all four 3x12sT screws.
- ⚠ The screw cuts thread directly into the plastic, so there might be some resistance.

## STEP 13 What's left... (xLCD A)



- **You will no longer need these parts:**
- Old xLCD-cover (1x)
- xLCD-support-right (1x)
- xLCD-support-left (1x)
- Old xLCD-knob (1x)

## STEP 14 xLCD B



**⚠** These steps are valid only if you have the older **xLCD version B**. If you have the newer version A, skip to the end of the chapter.

- Take the old xLCD cover.
- Remove the M3n nut from the xLCD cover.
  - Pro Tip: Insert a screw as a handle and gently pull while wiggling it, to remove the nut.

## STEP 15 xLCD B: parts preparation (part 1)

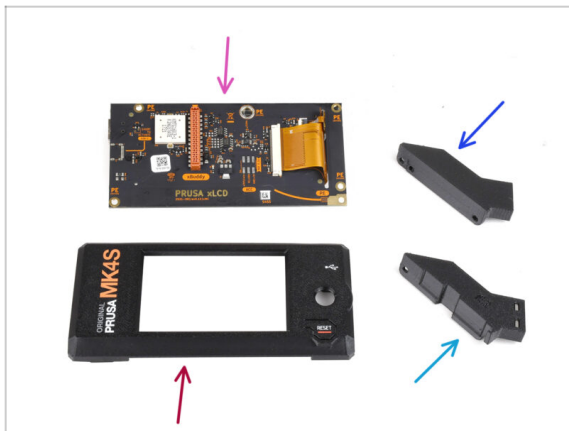

**⚠** These steps are valid only if you have the older **xLCD version B**. If you have the newer version A, skip these steps!

- **For the following steps, please prepare:**
- xLCD (1x) *you removed earlier*
- xLCD-cover (1x) *new part*
- xLCD-support-left (1x) *you removed earlier*
- xLCD-support-right (1x) *you removed earlier*

## STEP 16 xLCD B: parts preparation (part 2)

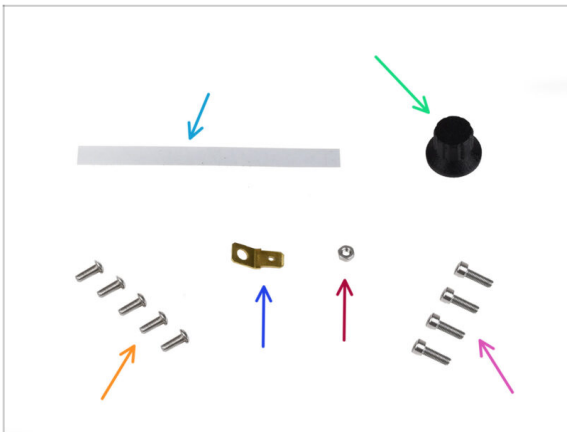

- **For the following steps, please prepare:**
- xReflector sticker set (1x) **new part**
- xLCD-knob (1x) *you removed earlier*
- M3x8rT screw (5x) *you removed earlier*
- Faston connector 6.3x0.8 (1x) *you removed earlier.*
- M3n nut (1x) *you removed earlier*
- M3x10 screw (4x) *you removed earlier*

## STEP 17 Installing the xReflector sticker (xLCD B)



- Peel the xReflector sticker off the protective layer.
- Apply it into the marked area on the inside of the new xLCD cover.
- Press the xReflector sticker strip all the way towards the xLCD-cover, so that it adheres properly.

### STEP 18 Installing the M3n nut (xLCD B)



- Install the M3n nut into the marked opening on the new xLCD cover.
- Tip: for better insertion of the nut, screw the nut onto the tip of one of the longer screws and push it into the hole. Then remove the screw.

### STEP 19 xLCD-support assembly (xLCD B)

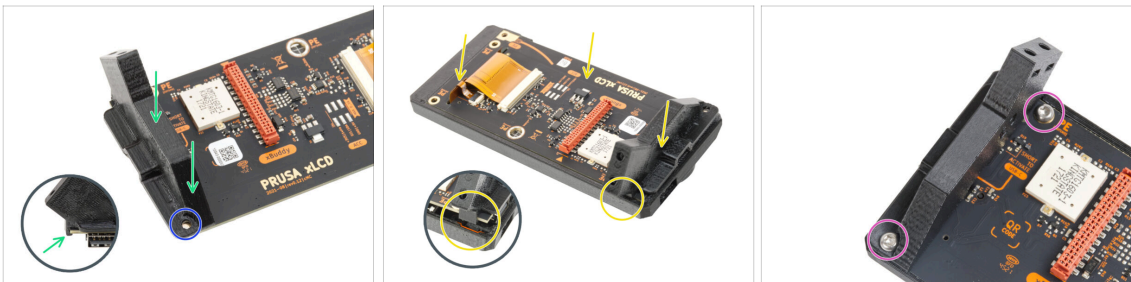

- Place the xLCD-support-right onto the USB-connector-side of the xLCD board. Notice there is a small hook that goes around the circuit board.
- Line up the hole in the plastic part with the hole in the xLCD board.
- Insert the xLCD with the support-right into the cover. Note the recess for the support-right in the xLCD-cover. The support must fit into the recess.
- Secure the xLCD-support-right and the xLCD board with two M3x8rT screws.

## STEP 20 xLCD-support-left assembly (xLCD B)



- ◆ Attach the xLCD-support-left on the xLCD board and align it with three holes in the board.
- ◆ Insert the PE Faston between the xLCD-support-left and the xLCD board. Align it with the hole and point the PE Faston slightly diagonally as you see in the picture.
- ◆ Secure all parts together with three M3x8T screws.

## STEP 21 Attaching the knob (xLCD B)



- ◆ Attach and push the xLCD-knob onto the xLCD encoder pin.
- ⓘ Note that there is a flat part on the encoder shaft. There is a geometry on the inside of the knob that should align with the flat part to seat the knob properly.

## STEP 22 Connecting the assembly (xLCD B)

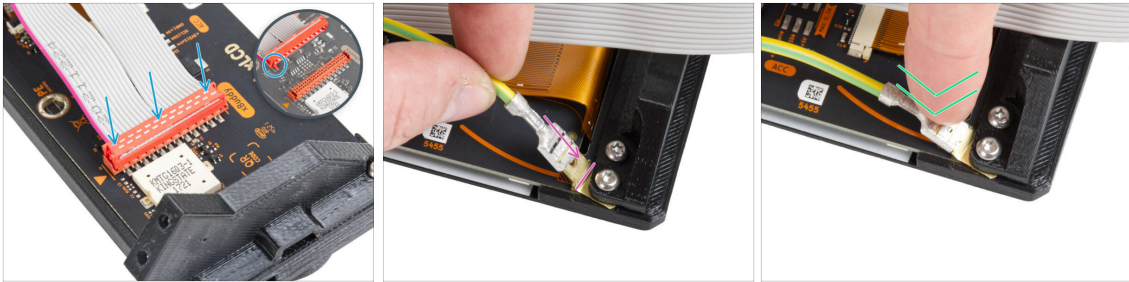

- Connect the xLCD cable to the xLCD board. Note the safety latch on the xLCD cable connector. It must be plugged into the side of the xLCD slot marked with the orange triangle on the board.
- ⚠ Make sure the xLCD cable is connected in the same orientation as seen in the picture. Otherwise, your display won't work**
- Take the end of the PE cable with square connector. Slide the connector onto the PE Faston all the way down.
- Bend the PE Faston down slightly so that it does not protrude too far from the back of the display. Curve the cable according to the drawing on the board.

## STEP 23 Attaching the assembly (xLCD B)

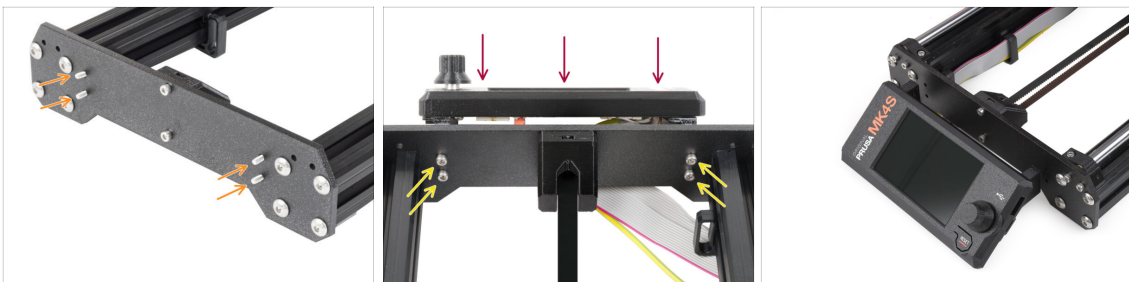

- Insert four M3x10 screws through the four holes in the front plate of the printer's frame.
- Attach the xLCD assembly onto the front plate. The screws should fit into the corresponding openings in the xLCD assembly.

### STEP 24 Haribo time!



- ◆ It was a bit more challenging now, wasn't it?
- ◆ Eat two gummy bears.
- ⚠ Follow these instructions! The **exact number of gummy bears is crucial** to properly completing the upgrade.

---

### STEP 25 Well...



- ◆ Let's go to the next chapter: 4. **Upgrading the Nextrunder.**

## 4. Upgrading the Nextrunder

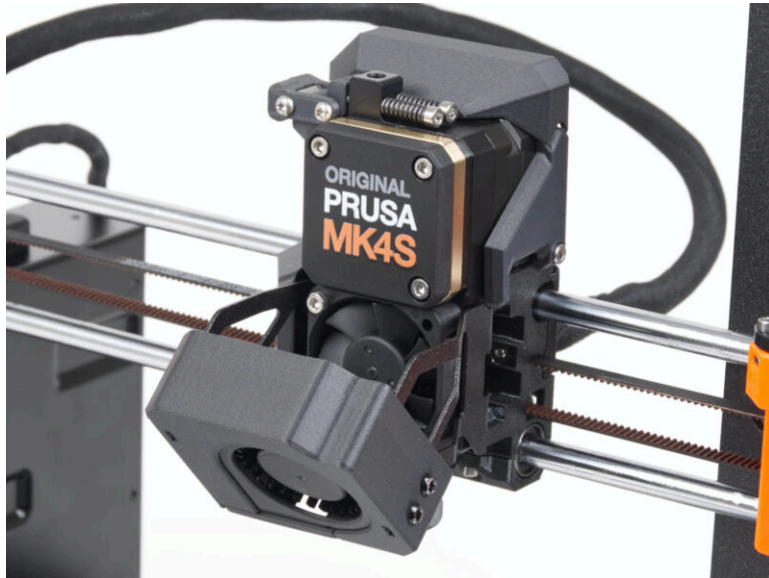



### STEP 1 MK4S MMU3

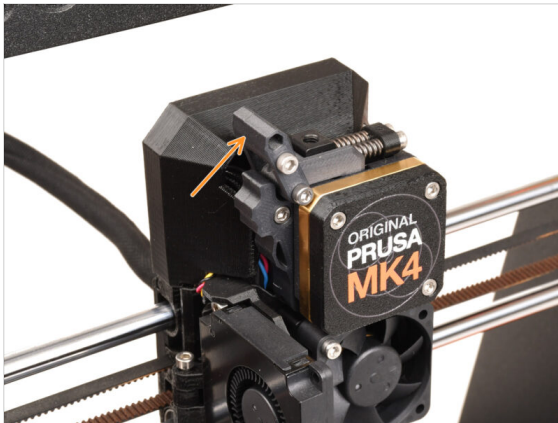

⚠ If you have used **MMU3** unit on your MK4/MK3.9 printer, your extruder is slightly different. In that case, please proceed to the dedicated chapter:

🟡 4B Upgrading the nextruder MMU3

⬛ If you have a single-material printer, **continue to the next step.**

### STEP 2 Tools necessary for this chapter

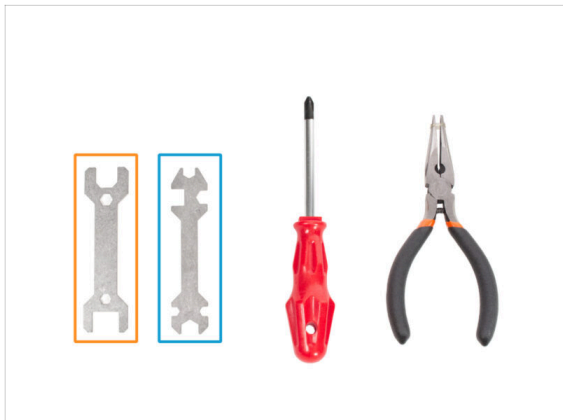
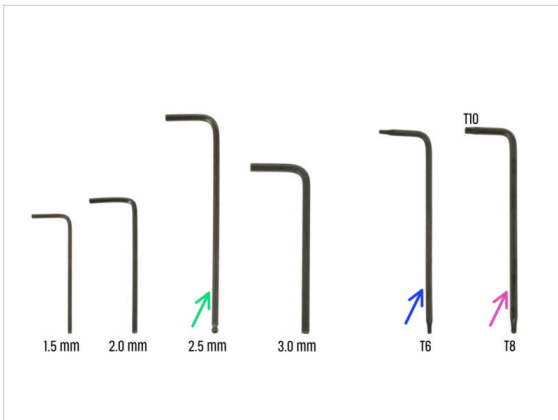

⬛ **For this chapter, please prepare:**

- 🟢 2.5mm Allen key
- 🟡 Torx key T6
- 🟣 Torx key T10/8
- 🟠 Wrench 13-16
- 🟦 Universal wrench

### STEP 3 Protecting the heatbed

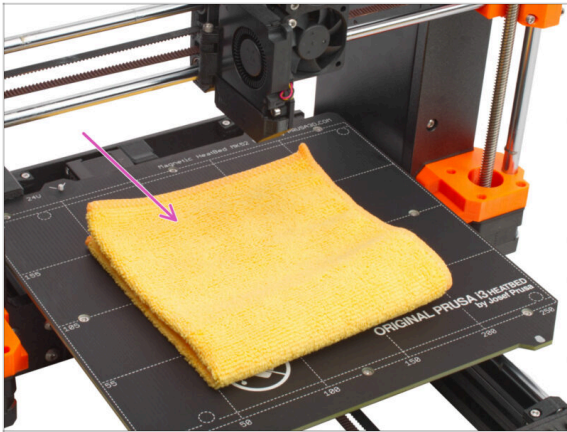

⚠ It is **HIGHLY RECOMMENDED** to protect the heatbed.

- Use any cloth or piece of fabric, which is thick enough and cover the heatbed. This will ensure you won't damage (scratch) the surface during the disassembly.

### STEP 4 Uncovering the Nextruder



- Move the Nextruder approximately to the center of the X-axis to gain better access to the entire assembly.
- Remove the LoveBoard-cover by sliding it up.
- From the right side of the Nextruder, release and remove the M3x10 screw.
- Remove the LoveBoard-cover-right from the printer.

## STEP 5 Removing the idler-swivel

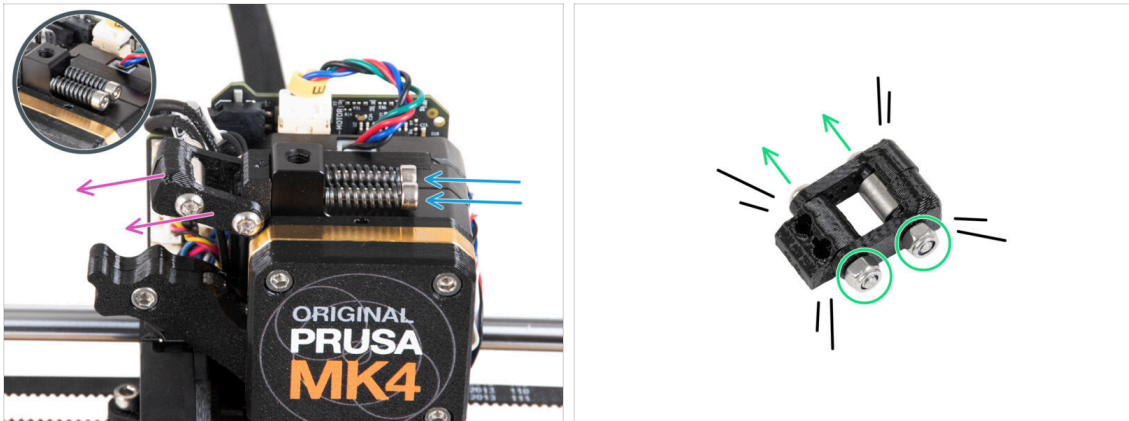

- Remove two M3x30 screws with the springs from the Nextruder.  
📌 Do not discard any of these parts. You will need them again later on.
- Remove the idler-swivel assembly from the Nextruder.
- Release two M3n nuts and, using the T8 Torx key, remove two M3x20rT screws from the idler-swivel assembly.
- Tear the assembly into its parts.
- ⓘ You will no longer need the plastic parts.

## STEP 6 Assembling the Idler-swivel: parts preparation

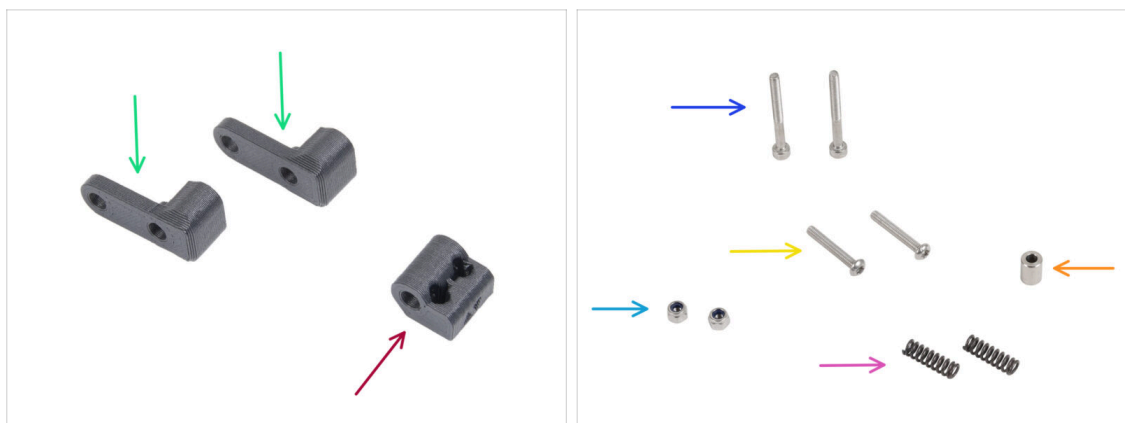

⬛ For the following steps, please prepare:

- 🟢 Idler-swivel (2x) *new part*
- 🔴 Idler-nut (1x) *new part*
- 🟡 M3x30 screw (2x) *you removed earlier*
- 🟠 M3x20rT screw (2x) *you removed earlier*
- 🟢 M3nN nut (2x) *new ones*
- 🟡 Spring 15x5 (2x) *you removed earlier*
- 🟠 Spacer 6x3.1x8 (1x) *you removed earlier*

## STEP 7 Assembling the Idler-swivel



- 🟢 Push the M3x20rT screw all the way through one of the idler-swivel.
- 🟡 Slide the spacer onto the screw.
- 🟢 Place the second idler-swivel from the opposite side of the screw.
- 🟡 From the other side, attach the M3nN nut to the screw. Hold the nut using the universal wrench and tighten the screw. **Tighten just lightly!** The spacer must rotate freely.

## STEP 8 Assembling the Idler-nut



- ✿ Insert the Idler-nut into the Idler-swivel assembly. Make sure that both parts are oriented correctly according to the picture.
- ✿ Secure both parts together by inserting the M3x20rT screw from the same side, like the first screw.
- ✿ Secure the screw with M3nN nut. **Do not overtighten the nut.** It must be possible to move with the Idler-swivel on the Idler-nut.
- Keep the idler-swivel assembly aside for now.

## STEP 9 Disconnecting the Nextruder cables



- ⚠ Note there are safety latches on each of the connectors which must be pushed in, in order to remove the connector.
- ✿ Disconnect all the small connectors from the left side of the LoveBoard.
- ✿ Disconnect the Nextruder motor (labeled E).
- ✿ Disconnect both cables from the right side of the Nextruder.

### STEP 10 Removing the print fan assembly

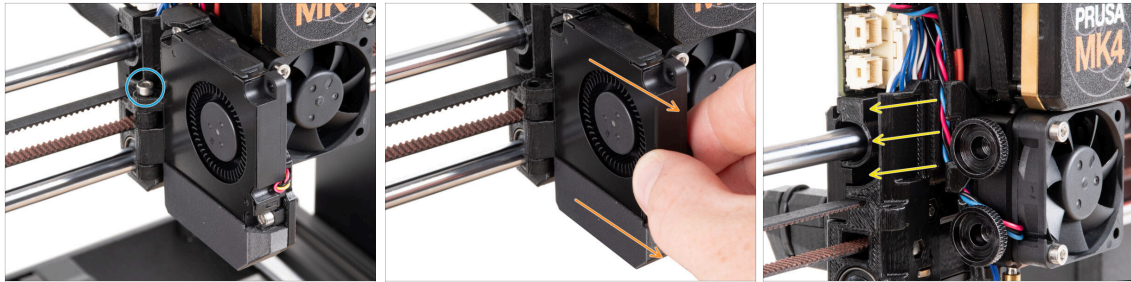

- Remove the M3x30 screw from the fan-door hinge.
- Pull the print fan assembly from the Nextruder.
- Remove all the disconnected cables from the cable channel.

### STEP 11 Removing the heatsink fan&hotend

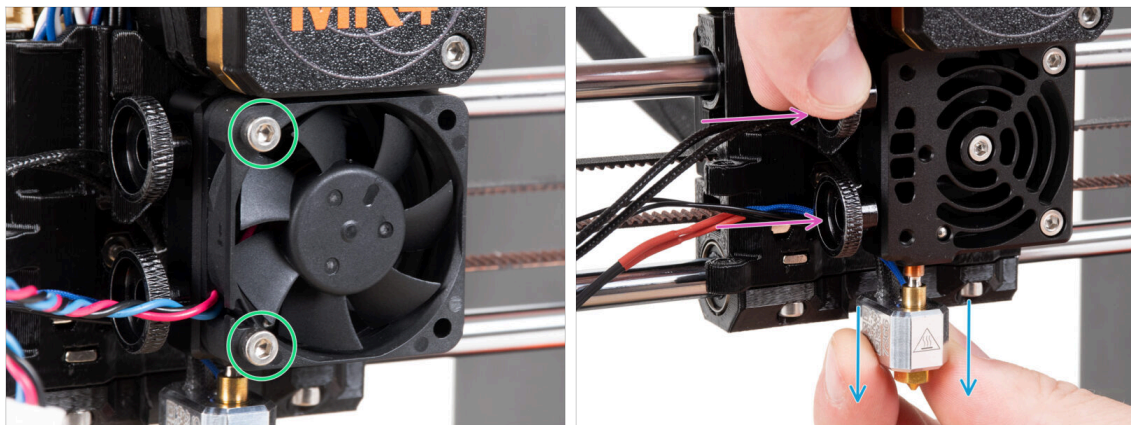

- Release two M3x18 screws securing the heatsink fan and remove the fan from the Nextruder.
- Loosen both thumb screws.
- Pull out the hotend assembly from the Nextruder.

## STEP 12 Removing the Nextruder

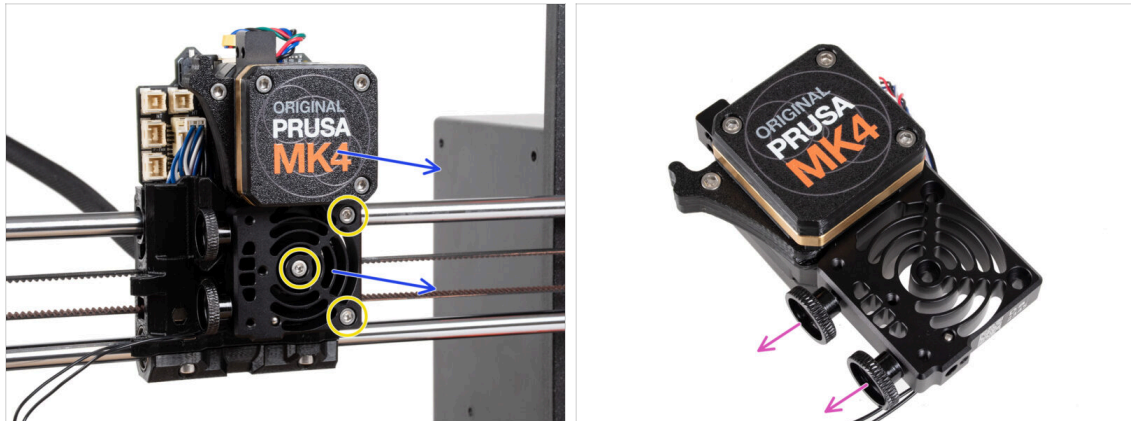

- Loosen all three M3x10 screws mounting the Nextruder assembly.
  - ⚠ **When loosening the Nextruder, hold it with your hand to prevent it from falling.**
- Remove the Nextruder assembly from the X-carriage.
- Put the printer aside for a moment and let's get on with Nextruder.
- Remove both thumb screws from the heatsink.
  - ⚠ **Do not discard any parts.**

## STEP 13 Gearbox versions



⚠ There were two types of the gearbox on the **MK4** printer.

◆ The older design with **four screws**.

◆ The newer design with **three screws**.



The upgrade process is the same for both types of the gearbox.



Another difference is that the older gearbox uses a plastic spacer, while the newer one has a metal washer. Replacing it isn't necessary, as it as it requires a full gearbox teardown and offers no functional advantage.

⚠ **WARNING:** The following procedure must be carried out with extreme care and caution. No part of the gearbox itself should be removed, unless instructed to.



If you lose any part of the assembly, please contact our customer support.



**STEP 14** Uncovering the gearbox

- Release and remove the screws securing the PG-case.
  - When removing the screws, hold the PG-ring (gold-brass part) to prevent it from sliding out.
- **Extremely carefully and slowly remove the PG-case from the Nextruder.**
- ⚠ **The gearbox will remain open for some time. Take care to prevent any dirt or debris from entering it.**
- Insert **three** M3x25 screws (you removed earlier) into the marked openings on the PG-ring. **Do not tighten too much**, 2-3 turns are enough. This is just a temporary fix to keep the gearbox assembly in place.
- If you have the newer type of the gearbox, using the Torx T6 key, remove the M3x25 socket set screw securing the idler.

**STEP 15** Removing the extruder idler

- Slowly and carefully remove the extruder idler from the Nextruder.
- Let's take our hands off the gearbox for a moment and move on to upgrading the extruder idler part.
- ⚠ **The gearbox will remain open for some time. Take care to prevent any dirt or debris from entering it.**
- Release and remove the M3x6 screw from the Idler-lever-b.
- Remove the Idler-lever-b (top part) from the idler assembly.
- Remove both bearings and pins from the Idler-lever-a (base part).
- Pull out the tubular spacer from the Idler-lever-a.

## STEP 16 Extruder idler assembly: parts preparation

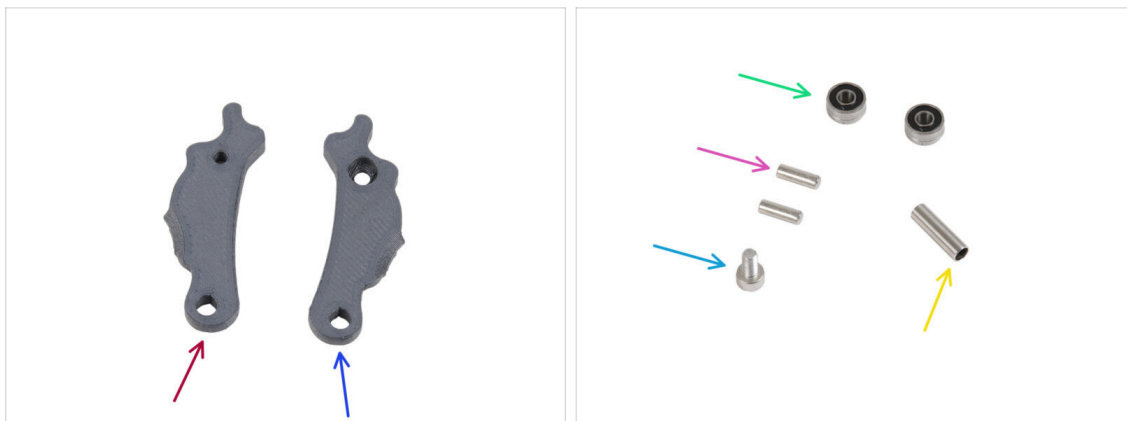

● For the following steps, please prepare:

- Idler-lever-a (1x) *new part*
- Idler-lever-b (1x) *new part*
- Bearing 693 2RS (2x) *you removed earlier*
- Pin 2.9x8.5 (2x) *you removed earlier*
- M3x6 screw (1x) *you removed earlier*
- Tubular spacer 13.2x3.8x0.35 (1x) *you removed earlier*

## STEP 17 Upgrading the extruder idler



- Place both bearings into the Idler-lever-a.
- Insert the 2.9x8.5 pins into each bearing 693 2RS, as seen in the picture.
- Close up with the Idler-lever-b part and secure it with the M3x6 screw. **Do not overtighten the screw.** Both bearings must be able to rotate without significant resistance.
- From the same side, push the tubular spacer into the assembly. The "bottom" of the tubular spacer must be flush with the bottom part of the Idler assembly.

## STEP 18 PG-cover: parts preparation

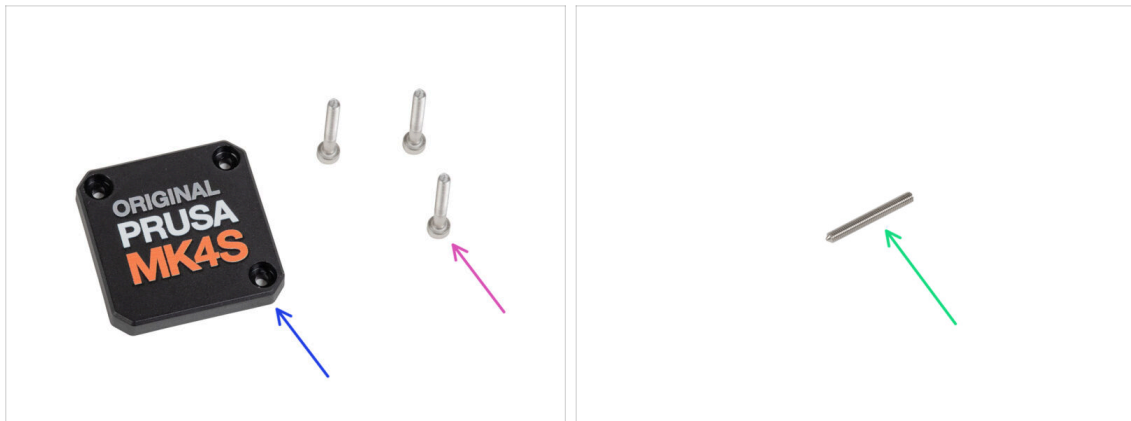

● **For the following steps, please prepare:**

- PG-case (1x) *new part*

ⓘ The new cover doesn't require the round plastic washer like the previous version.

- M3x25 screw (3x) *you removed earlier*

ⓘ The three M3x25 screws are fixing the PG-ring at this moment. Keep them in place for a while.

- Socket set screw M3x25 (1x)

ⓘ Use either the one you removed earlier or the newly supplied one if you have the older type of gearbox.

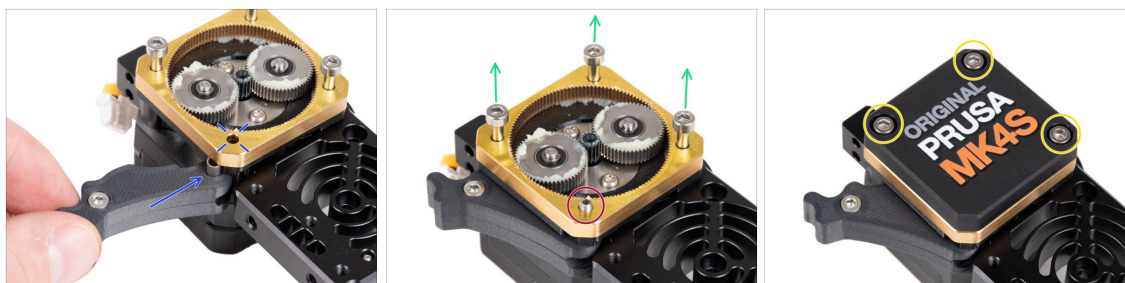
**STEP 19** Installing the idler and PG-cover

- Back to the Nextrunder.
- Insert the idler assembly between the PG-ring and the extruder motor. There is a cutout for the spacer in the main-plate. Line up the idler spacer with the hole in the PG-ring.
- Secure both parts with the socket set screw M3x25. Do not over-tighten the screw! The screw protrudes from the PG-ring after tightening.
- Carefully remove all three M3x25 screws.
  - When removing the screws, hold the PG-ring (gold-brass part) to prevent it from sliding out.
- Place the PG-case on the gearbox and secure it with three M3x25 screws. **Do not tighten them completely at this moment.**
  - ⓘ The screws on the PG-case will be completely tightened during the self-test in the final chapter.

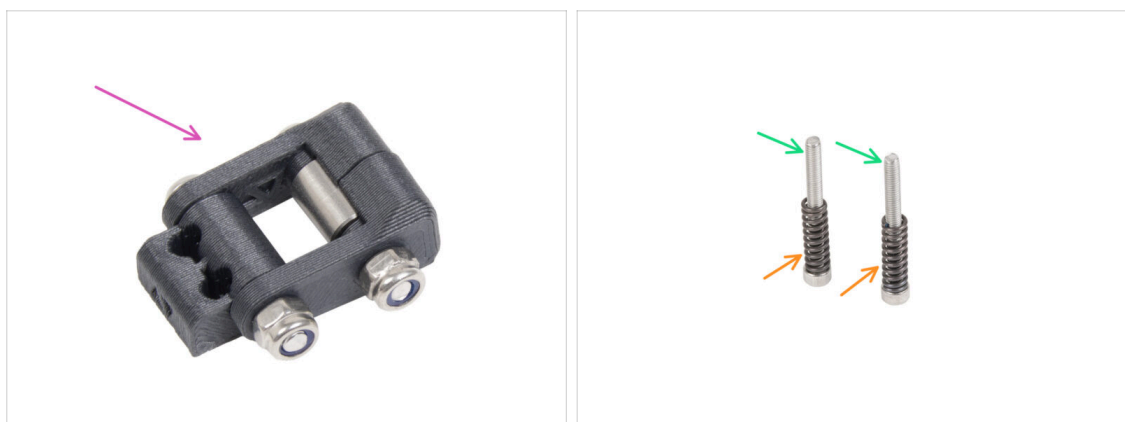
**STEP 20** Mounting the idler-swivel: parts preparation

- **For the following steps, please prepare:**
- Idler-swivel assembly (1x) *you assembled earlier*
- M3x30 screw (2x) *you removed earlier*
- Spring 15x5 (2x) *you removed earlier*

## STEP 21 Mounting the Idler-swivel assembly

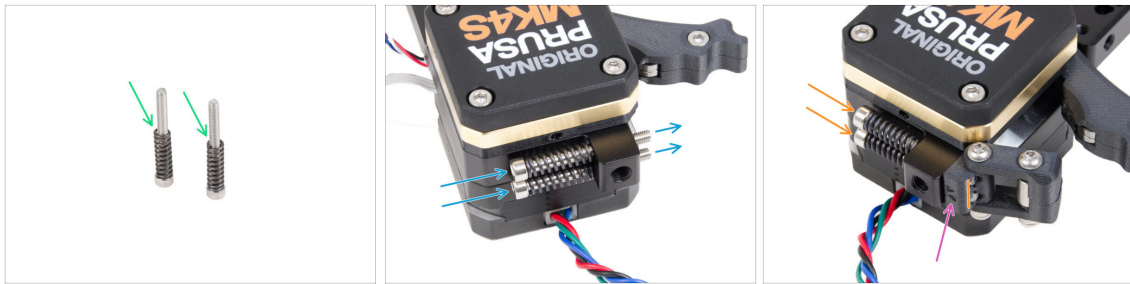

- Attach the spring 15x5 on both M3x30 screws.
- Push the two screws with the springs through the holes in the protrusion on the heatsink. There are no threads inside.
- Attach the Idler-swivel assembly to the screws. See the correct orientation of the Idler-nut. The side with version marking must be visible. See the picture.
- Tighten both screws. **Stop tightening as soon as the screw tips reach the front face of the idler nut.**

## STEP 22 Assembling the Nextruder: parts preparation



◆ **For the following steps, please prepare:**

- MK4S fan holder (1x)
- Heatsink spacer (1x)
- M3x12 screw (3x)

⚠ **Do not reuse the M3x10 screws you removed earlier. Due to the new parts, longer M3x12 screws are now required.**

## STEP 23 Assembling the Nextruder



- ◆ From the front side of the Nextruder (side with the printer logo pg-case), insert three M3x12 screws in the heatsink.
  - ◆ From the opposite side of the Nextruder, fit the heatsink spacer onto the three screws.
    - ◆ Make sure the protrusion protrudes towards you (like the screws).
  - ◆ From the extruder motor side of the heatsink, attach the MK4S fan holder to the heatsink.
- ⚠ **Avoid pinching the NTC thermistor cable.** Guide it through the cutout as shown in the detail.

## STEP 24 Attaching the Nextruder

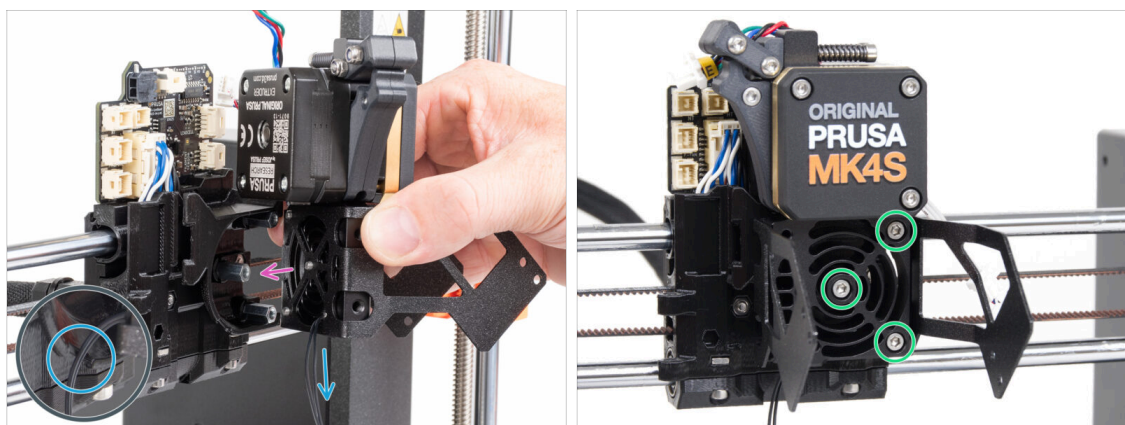

- ◆ Place the Nextruder assembly onto the spacers on the X-carriage. Line up the three screws with the three spacers.
  - ◆ There is a cutout in the plastic part. **Guide the thermistor cable through this cutout.**
- ⚠ **DO NOT PINCH ANY OF THE CABLES!**
- ◆ Align the heatsink screws with the spacers on the X-carriage and join both parts together by tightening them. Start with the middle one.

## STEP 25 Connecting the NTC thermistor

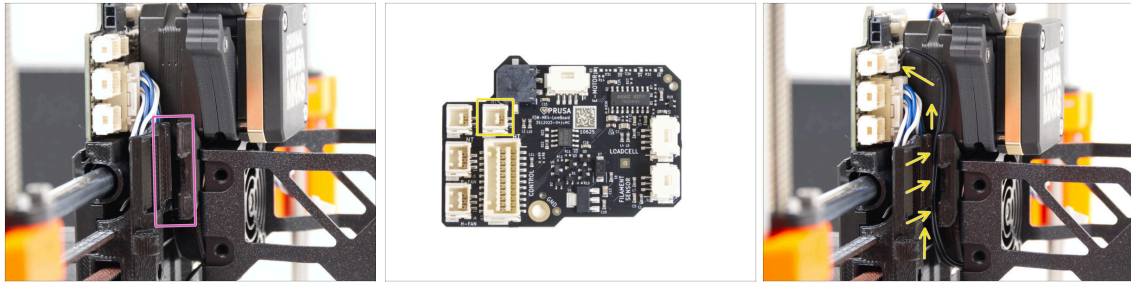

- ◆ Locate the cable channel on the left side of the X-carriage. We will guide some of the cables through this channel in the following steps
- ◆ Guide the NTC thermistor through the cable channel in the X-carriage up to the LoveBoard slot.

## STEP 26 Assembling the hotend fan: parts preparation

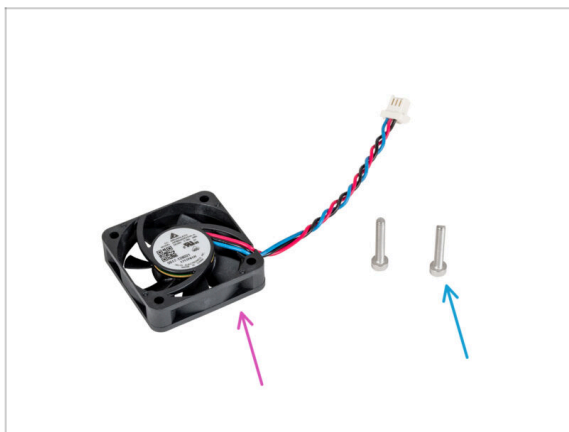

- ◆ **For the following steps, please prepare:**
- ◆ Hotend fan (1x) *you removed earlier*
- ◆ M3x18 screw (2x) *you removed earlier*

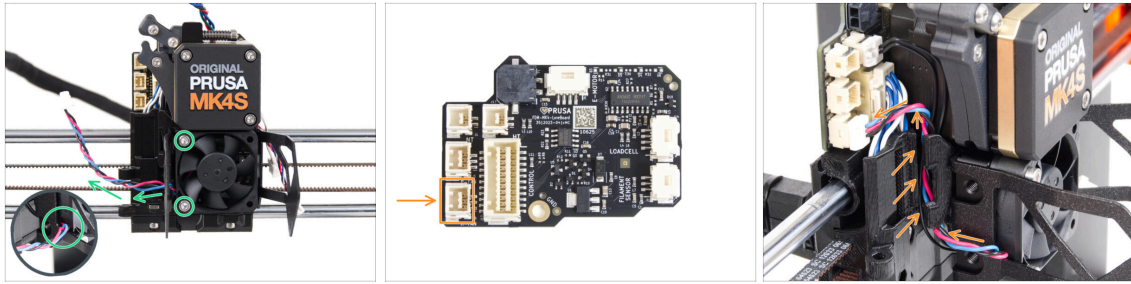
**STEP 27** Assembling the hotend fan

- ◆ Attach the hotend fan onto the heatsink with two M3x18 screws on the left side. **Tighten the screw gently, but firmly**, otherwise the plastic housing may crack. The cable must be pointing towards the lower-left corner.
  - ⚠ There is a sticker on the hotend fan, the sticker must be on the rear side of the fan - not visible.
  - ◆ Guide the fan cable through the cutout in the fan holder.
  - ◆ Guide the fan cable between the thumb screw holes under the cable channel up and connect it to the **lower slot** on the LoveBoard.

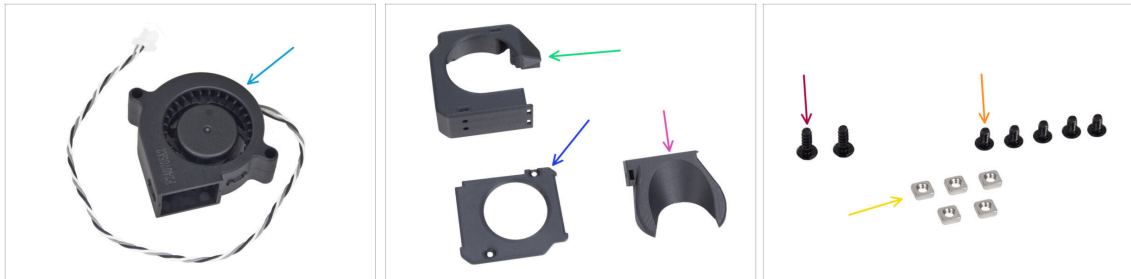
**STEP 28** Print fan blower: parts preparation

- ◆ **For the following steps, please prepare:**
  - ◆ MK4S Print fan blower (1x)
  - ◆ Fan-case (1x)
  - ◆ Fan-case-cover (1x)
  - ◆ Fan-shroud (1x)
  - ◆ 3x8sT screw (2x)
  - ◆ M3x5rT screw (5x)
  - ◆ M3nS nut (5x)



## STEP 29 Assembling the print fan case



- ◆ From the flat surface of the Fan-case, insert two M3nS nut all the way into the holes.
- ◆ **Double-check** from the side that the inserted nut is aligned with the hole in the part.
- ◆ From the opposite side, insert two M3nS nuts all the way into the holes. Check that nuts are fully inserted.
- ◆ Insert one M3nS nut into the hole in the Fan-shroud.

## STEP 30 Assembling the print fan blower



- ◆ Insert the MK4S print fan blower into the print fan blower case.
- ◆ Guide the print fan blower cable through the cable channel in the Fan-case.
- ◆ Close the fan with Fan-case-cover.
- ◆ Secure the cover with two 3x8sT screws.
- ⓘ The screws cut thread directly into the plastic, so there might be some resistance.

**STEP 31** Assembling the fan shroud

- ① Attach the Fan-shroud to the print fan blower assembly. Notice two teeth on the fan shroud and two rectangular holes in the blower assembly.
- First, insert those teeth into the rectangular cutouts.
- Close the Fan-shroud and secure it with the M3x5rT screw.
- ⚠ Use reasonable force to avoid breaking the parts.

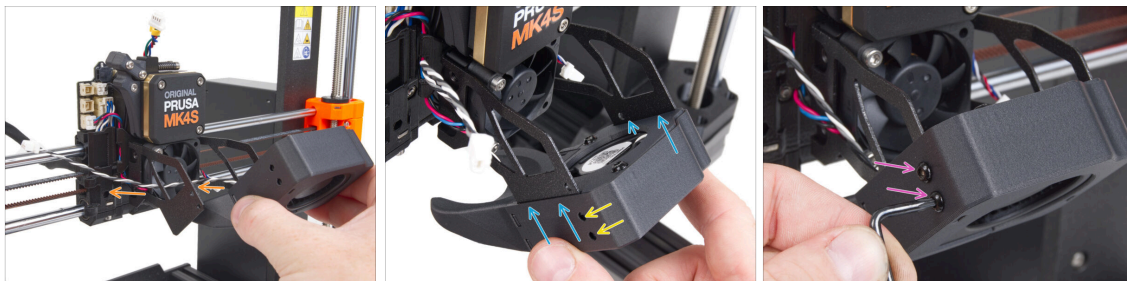
**STEP 32** Mounting the print fan blower assembly

- Take the print fan blower assembly and guide the fan cable through the cutout on the left side of the fan holder.
- 📌 Use the same cutout through which the heatsink fan cable already guides.
- Slide the side pockets of the print fan blower assembly onto the two "forks" of the fan holder.
- Ensure that the holes of both parts are aligned.
- From the left side of the fan holder, secure both parts together using two M3x5rT screws.

### STEP 33 Connecting the print fan blower

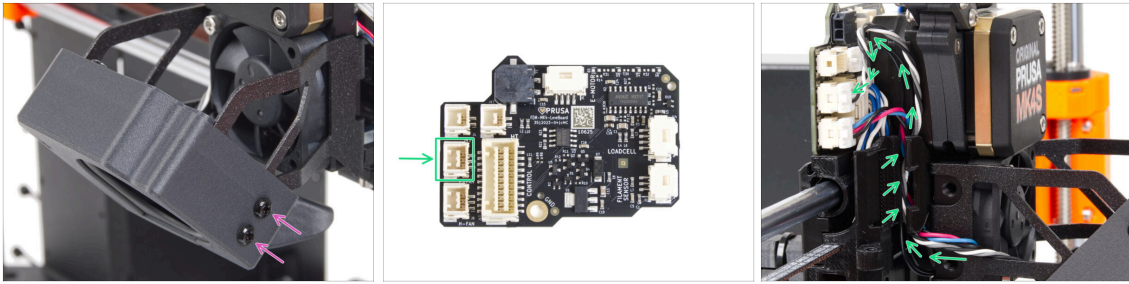

- ◆ From the right side of the fan holder, secure both parts together using two M3x5rT screws.
- ◆ Guide the print fan blower cable through the cable channel in the X-carriage and plug the connector to the middle slot on the LoveBoard.

### STEP 34 Prusa Nozzle CHT: parts preparation



- ◆ **For the following steps, please prepare:**
- ◆ MK4 hotend assembly (1x) *you removed earlier*
- ◆ New Prusa Nozzle CHT 0.4 (1x)
- ◆ Nextruder Silicone sock (1x)
- ⓘ The Nextruder Silicone Sock is optional but recommended for stable temperatures, hotend cleanliness, and protection during high-temperature printing.
- ◆ For more information, read the article [Nextruder Silicone Sock](#).

## STEP 35 Removing the Prusa Nozzle

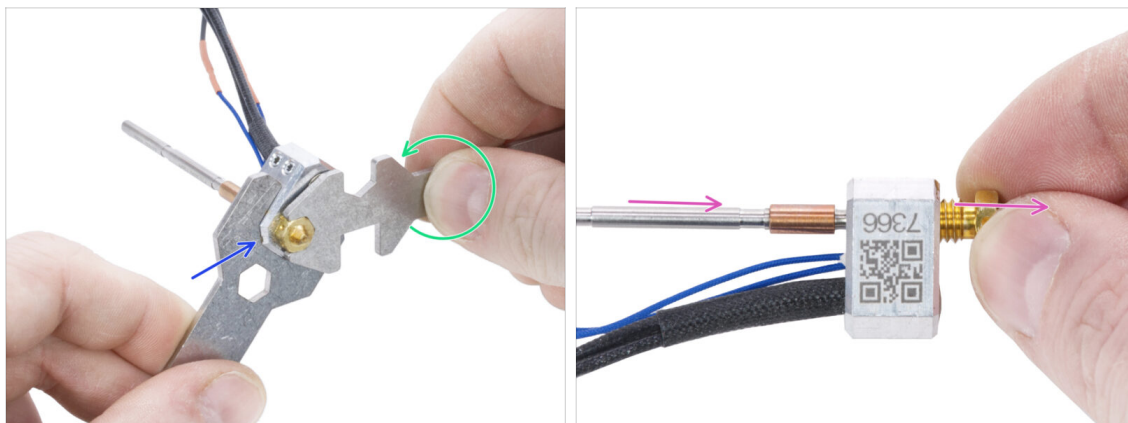

- ◆ Using the wrench 13-16 grasp the heaterblock.
- ◆ Using the 7mm cutout in the universal wrench, grasp the nozzle and loosen it.
- ◆ Manually release and remove the Prusa nozzle from the hotend assembly.

## STEP 36 Installing the Prusa Nozzle CHT



- ◆ Screw the new nozzle all the way into the heaterblock until the nozzle touches the heaterblock surface.
- ◆ Grasp the heaterblock with the wrench 13-16.
- ◆ Using the 7mm cutout in the universal wrench, tighten the nozzle against the heaterblock. **Do not use any extra force!**
  - ⓘ The specified torque value is 1.5 Nm (13.3 lb-in). The use of a torque wrench is recommended.
- ◆ Put the silicone sock back on the heaterblock. This is optional.
- ⓘ Keep the removed Prusa Nozzle as a spare part. While it is fully compatible with the MK4S/MK3.9S printer, we recommend using the new Prusa Nozzle CHT, which features improved material flow technology.

## STEP 37 Inserting the hotend assembly: parts preparation



- ◆ For the following steps, please prepare:
- ◆ Hotend assembly (1x) you assembled earlier
- ◆ Thumb screw (2x) you removed earlier

## STEP 38 Inserting the hotend assembly

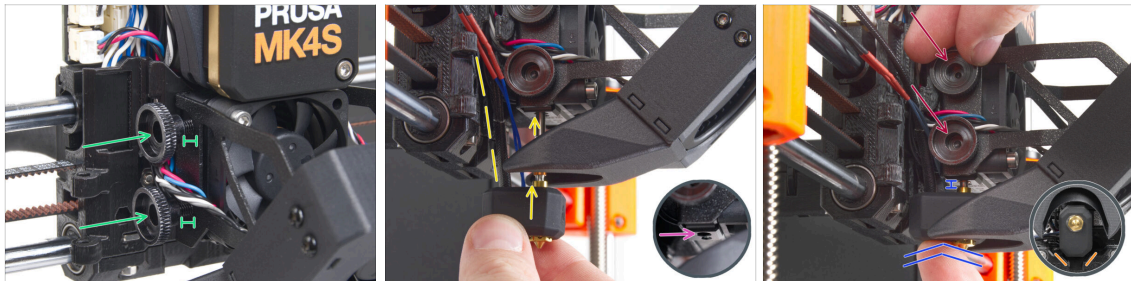

- ◆ Insert two thumb screws into the heatsink. **Do not tighten them completely.** Two turns are enough for now.
- ◆ Look closely at the underside of the heatsink and find the hole for the hotend assembly.
- ◆ Insert the hotend assembly tube in the hole and slide the whole thing into the heatsink.
- ◆ Push the hotend assembly all the way into the heatsink. There should be approximately a 2 mm gap between the heatsink and the brass part of the nozzle.
- ◆ While pushing the hotend assembly in, **firmly tighten both thumb screws.**
- ⚠ **Avoid pinching any cable between the screws and the heatsink!**
- ◆ From the underside, check that the hotend is oriented correctly. It must fit between the cutouts in the X-carriage.

## STEP 39 Nozzle insertion check

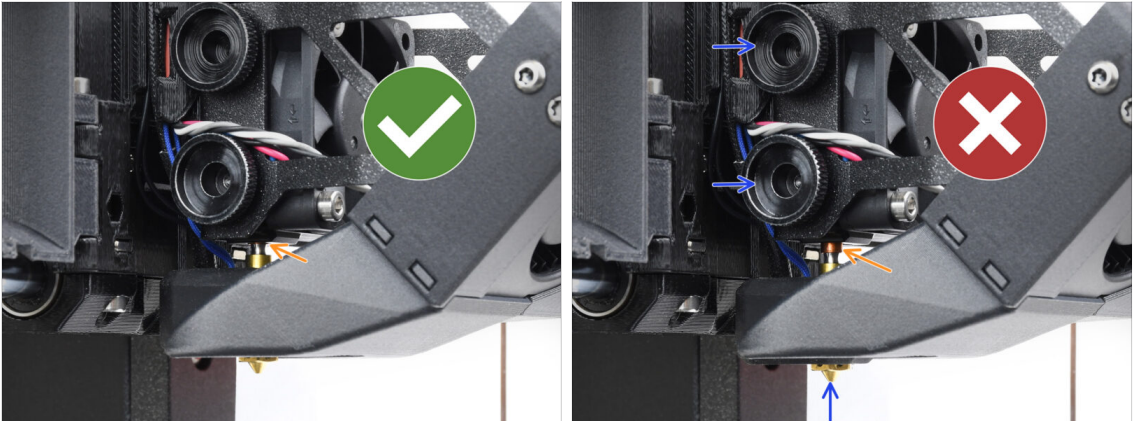

- Verify that the nozzle is fully inserted. The copper ring on the nozzle should be concealed within the heatsink if it is properly seated.
- ⓘ If not fully inserted, poor heat transfer may occur, potentially leading to issues like nozzle clogs.
- To adjust the nozzle position, loosen the thumbscrews, reposition the nozzle, and then retighten the screws, while pushing the hotend assembly up.

## STEP 40 Connecting the hotend cables

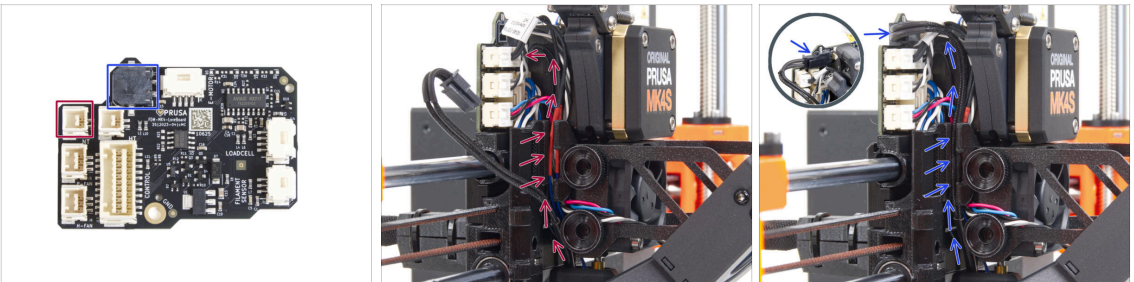

- Guide the hotend thermistor through the cable channel in the X-carriage and connect it to the LoveBoard.
- Guide the hotend heater through the cable channel in the X-carriage and connect it to the LoveBoard.

## STEP 41 Fan door cover: parts preparation

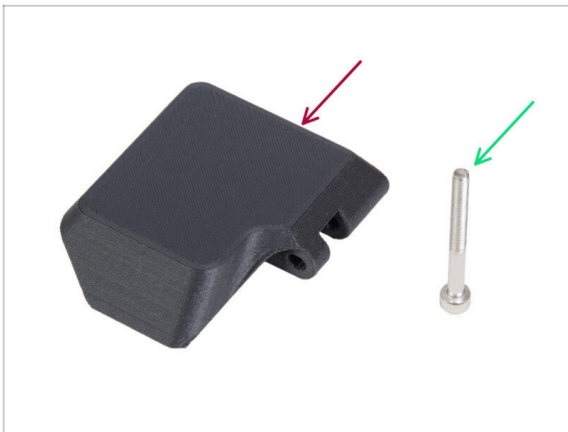

- For the following steps, please prepare:
- Fan-door-cover (1x)
- M3x30 screw (1x) *you removed earlier*

## STEP 42 Attaching the Fan-door-cover

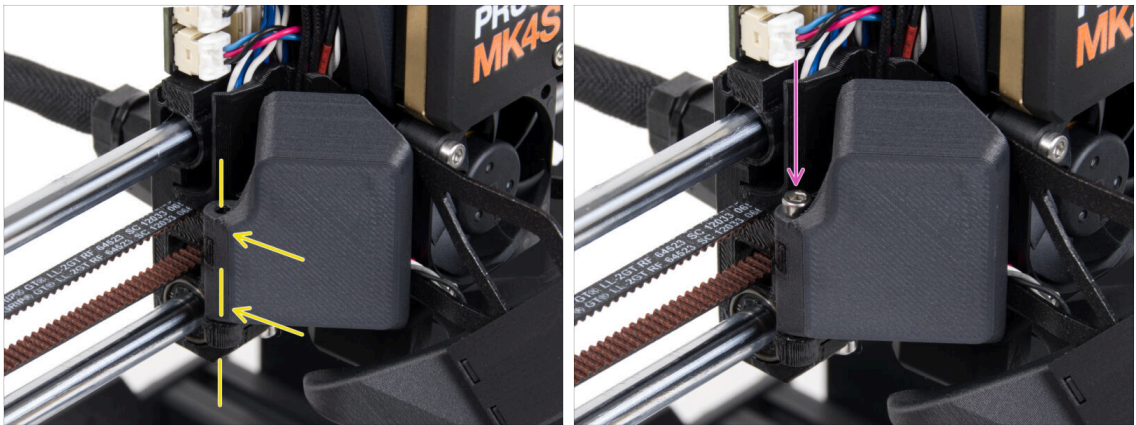

- Attach the Fan-door-cover hinge to its counterpart in the X-carriage. Holes in both parts must be aligned.
- Insert the M3x30 screw in the hinge on the fan-door. Fully tighten the screw, then loosen it by a quarter turn. **The fan-door must move freely!**

## STEP 43 Connecting the extruder cables

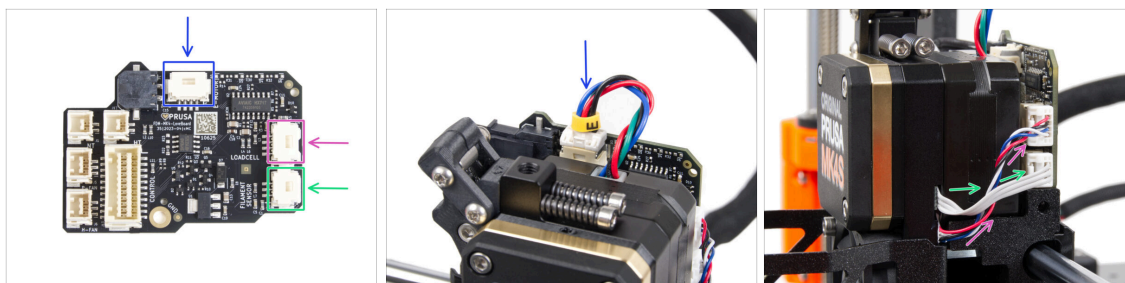

- ◆ Connect the Extruder motor cable to the connector on the top side of the LoveBoard.
- ◆ Connect the Loadcell cable coming from the right of the heatsink to the upper slot on the right side of the LoveBoard.
- ◆ Connect the filament sensor cable to the lower slot on the right side of the LoveBoard.

## STEP 44 LoveBoard: Wiring check



**⚠ Before covering the electronics, check the connection of all cables. Click on high-resolution preview in the top left corner.**

- ◆ **Close the idler mechanism before proceeding to the next step if you haven't already done so. Use the following sequence:**
  - ◆ Close the extruder idler to the extruder
  - ◆ Close the idler-swivel and lock it over the extruder idler assembly



## STEP 45 Covering the LoveBoard: parts preparation

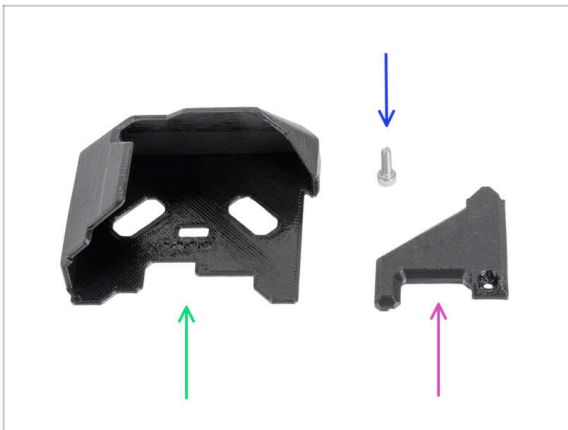

- ◆ For the following steps, please prepare:
- ◆ LoveBoard-cover (1x) *new part*
- ◆ LoveBoard-cover-right (1x) *new part*
- ◆ M3x10 screw (1x) *you removed earlier*

## STEP 46 Covering the LoveBoard: side cover

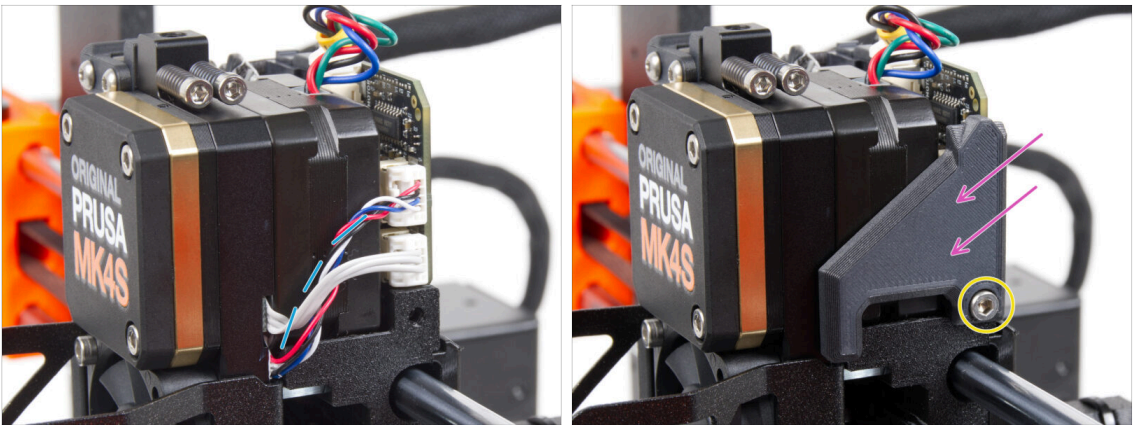

- ◆ Curve and arrange the cables on the right side of the extruder as you can see in the picture.
- ◆ Cover the cables with the LoveBoard-cover-right.
  - ⚠ **Do not pinch the cables!**
- ◆ Secure it with the M3x10 screw.
  - ⚠ **Make sure the LoveBoard-cover-right fits snugly against the right side of the extruder.** If not, it may cause the X-axis test to fail during the self-test because it will prevent the X-carriage assembly from moving all the way to the right.

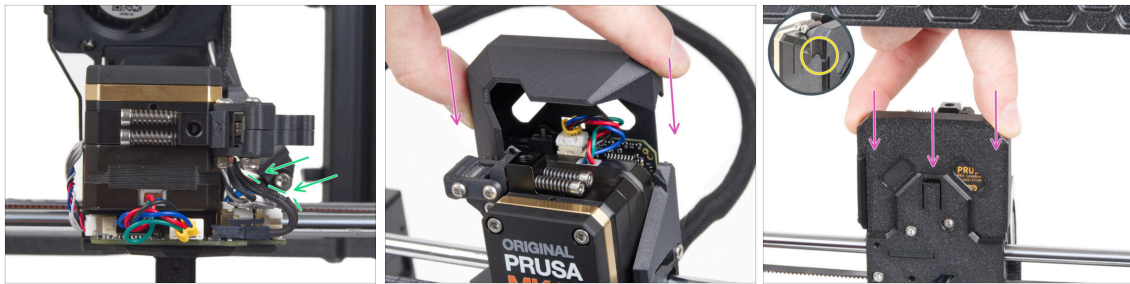
**STEP 47** Covering the LoveBoard: top cover

- ◆ Push all cables to the extruder to make more space around them. See the picture.
- ◆ Slide the Loveboard-cover on the extruder. And push it all the way down. The cover must go behind the X-carriage-back.
- ⚠ **Be careful not to pinch any cables.**
- ◆ Ensure that the two plastic covers fit together perfectly.

**STEP 48** What's left (part 1)

- ◆ **You will no longer need these parts:**
- ◆ Print fan assembly (1x)
- ◆ Old PG-case (1x)
- ◆ Old LoveBoard-cover (1x)
- ◆ Old LoveBoard-cover-right (1x)
- ◆ Old Idler-nut (1x)
- ◆ Old Idler-swivel (2x)
- ◆ Old Idler-lever-a (1x) and Idler-lever-b (1x)
- ⓘ The list continues in the next step ...

## STEP 49 What's left (part 2)

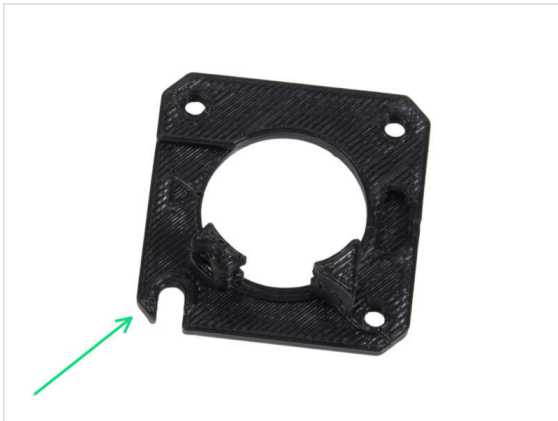

● Main-plate (1x)

ⓘ Although you didn't remove the Main-plate part from your printer, it was included in your upgrade kit. Over time, the part may experience slight wear, so it's wise to keep it as a spare.

● Prusa Nozzle (1x) *or your other purchased nozzle*

## STEP 50 Haribo time!



● Now you feel like you can fix anything, right? :)

● Eat two gummy bears.

**STEP 51** The Nextruder is upgraded!



- ◆ That was tough, but you made it!
- ◆ We're almost there. Let's continue with chapter 5. **Upgrading the connectivity.**

## 4B. Upgrading the Nextrunder (MMU3)

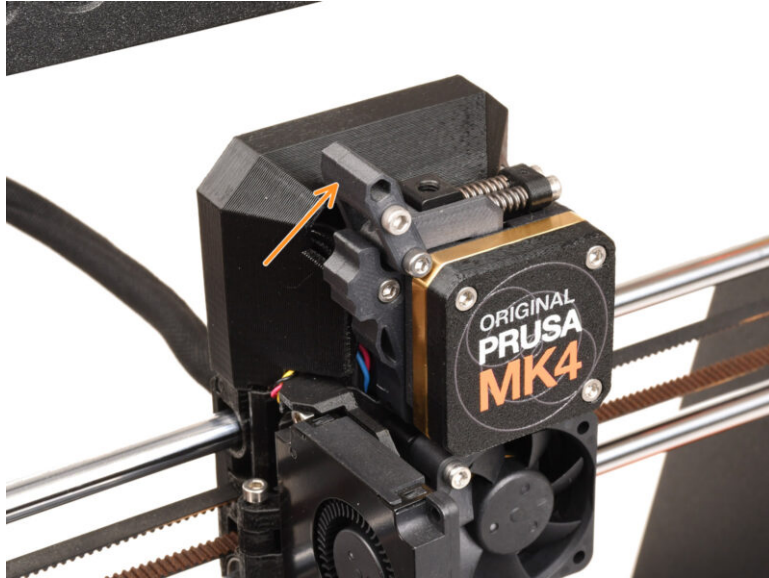

## STEP 1 Tools necessary for this chapter

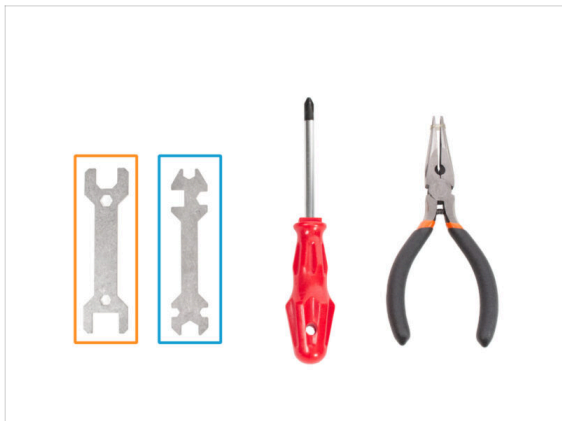
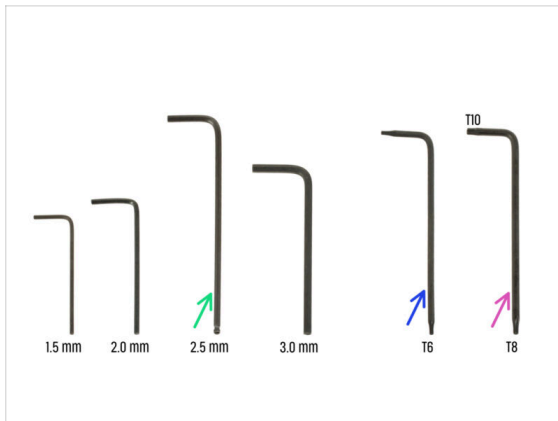

● For this chapter, please prepare:

- 2.5mm Allen key
- Torx key T6
- Torx key T10/8
- Wrench 13-16
- Universal wrench

## STEP 2 Protecting the heatbed

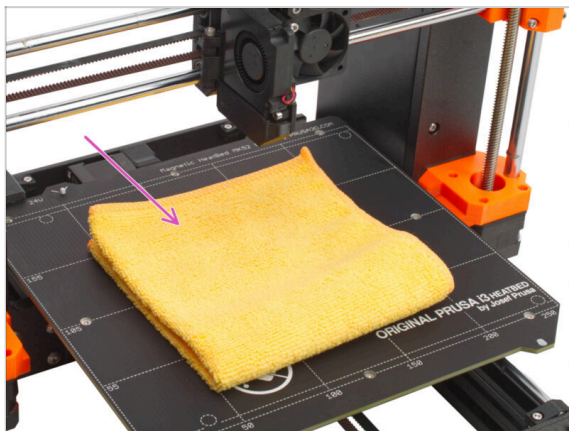

⚠ It is **HIGHLY RECOMMENDED** to protect the heatbed.

- Use any cloth or piece of fabric, which is thick enough and cover the heatbed. This will ensure you won't damage (scratch) the surface during the disassembly.

### STEP 3 Uncovering the Nextruder

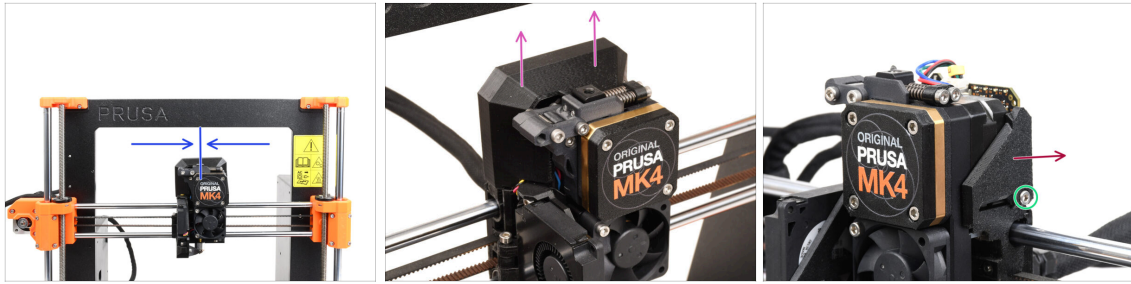

- i Some pictures may show three or four screws on the gearbox cover, but this does not affect the assembly process. You will be instructed if needed.
- Move the Nextruder approximately to the center of the X-axis to gain better access to the entire assembly.
- Remove the LoveBoard-cover by sliding it up.
- From the right side of the Nextruder, release and remove the M3x10 screw.
- Remove the LoveBoard-cover-right from the printer.

### STEP 4 Disconnecting the Nextruder cables

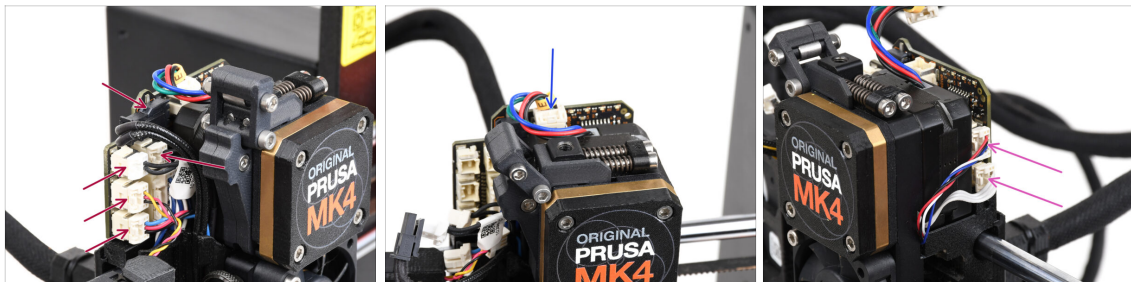

- ⚠ Note there are safety latches on each of the connectors which must be pushed in, in order to remove the connector.
- Disconnect all the small connectors from the left side of the LoveBoard.
- Disconnect the Nextruder motor (labeled E).
- Disconnect both cables from the right side of the Nextruder.

## STEP 5 Removing the print fan assembly

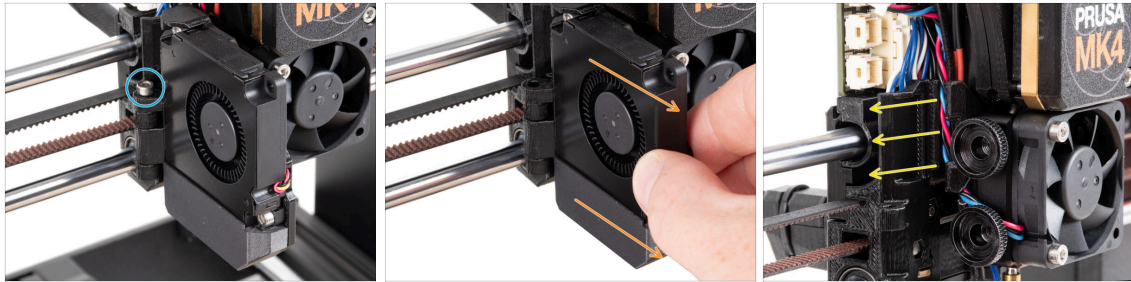

- Remove the M3x30 screw from the fan-door hinge.
- Pull the print fan assembly from the Nextruder.
- Remove all the cables from the cable channel.

## STEP 6 Removing the heatsink fan&hotend

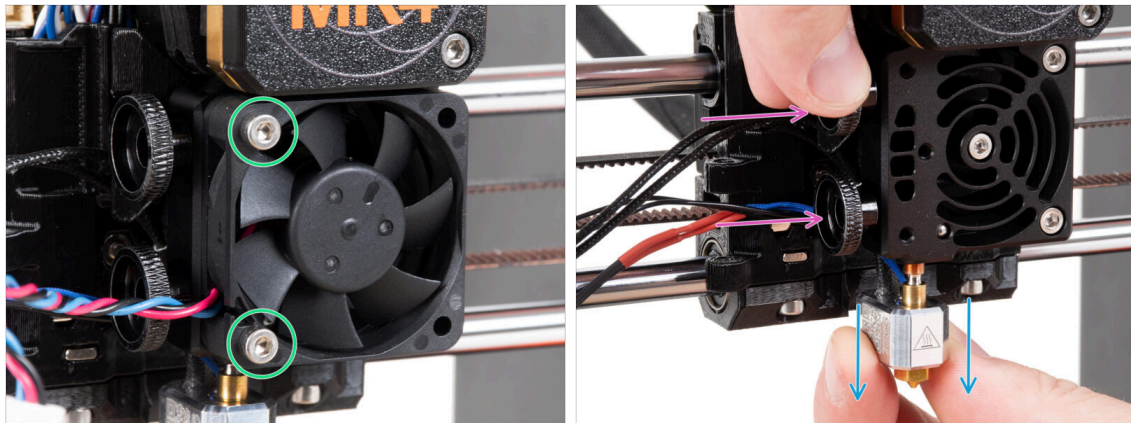

- Release two M3x20 screws securing the heatsink fan and remove the fan from the Nextruder.
- Loosen both thumb screws.
- Pull out the hotend assembly from the Nextruder.



## STEP 7 Removing the Nextruder

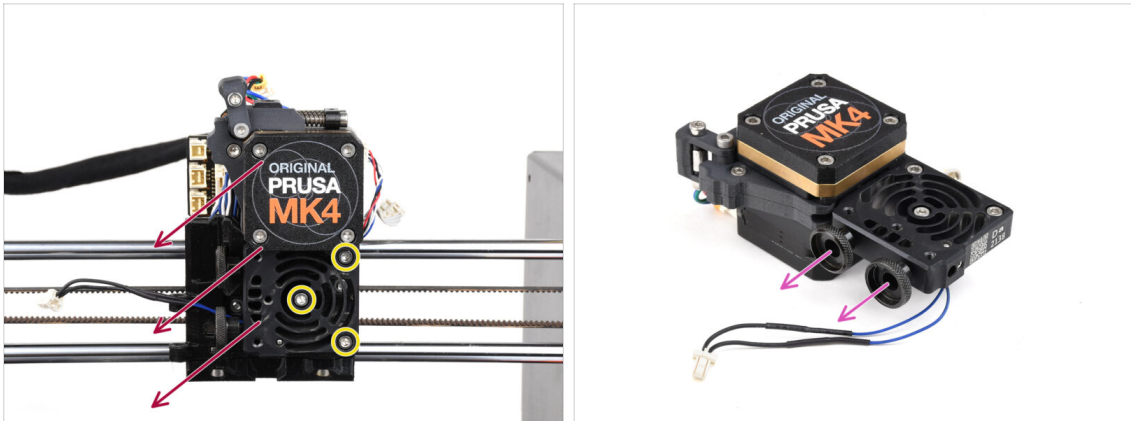

- Loosen all three M3x10 screws mounting the Nextruder assembly.
  - ⚠ **When loosening the Nextruder, hold it with your hand to prevent it from falling.**
- Remove the Nextruder assembly from the X-carriage.
- Put the printer aside for a moment and let's get on with Nextruder.
- Remove both thumb screws from the heatsink.
  - ⚠ **Do not discard any parts.**

## STEP 8 Uncovering the gearbox

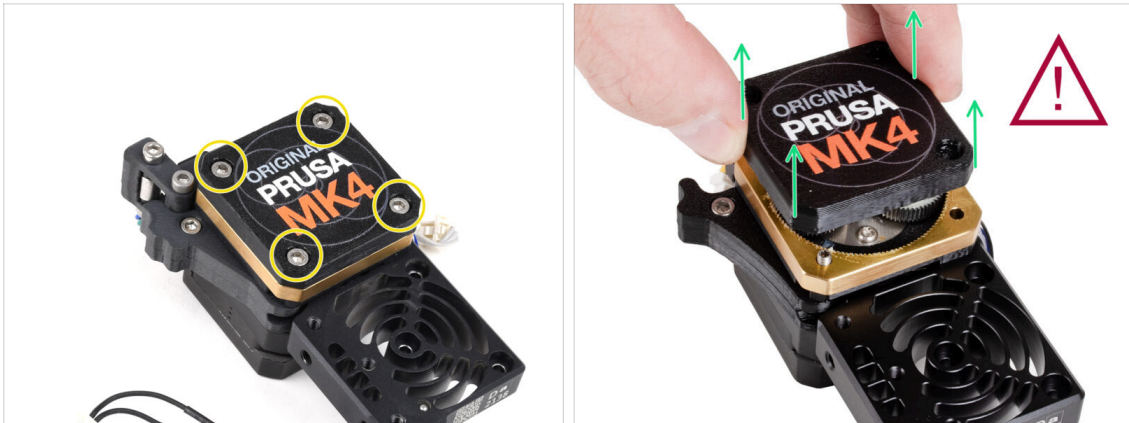

- i There are two variants of the gearbox cover, one with three screws and one with four screws. The procedure is the same for both.
- ! **WARNING:** The following procedure must be carried out with extreme care and caution. **No part of the gearbox itself should be removed.**
- i If any part of the assembly becomes loose, please contact our customer support.
- Release and remove the screws securing the PG-case.
  - When removing the screws, hold the PG-ring (gold-brass part) to prevent it from sliding out.
- ! Some versions of the printer have three, some have four screws.
- **Extremely carefully and slowly remove the PG-case from the Nextruder.**
- ! Prevent any dirt or debris from entering the gearbox.

## STEP 9 PG-case: parts preparation

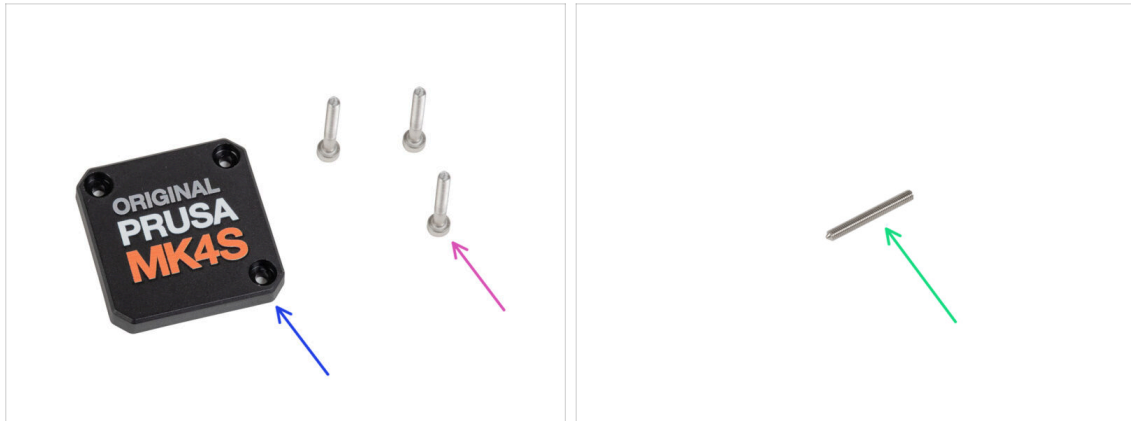

◆ For the following steps, please prepare:

◆ PG-case (1x) *new part*

ⓘ The older printed PG-case on MK4 required a washer on the inside. The new injection-molded MK4S version does not need the washer.

◆ M3x25 screw (3x) *you removed earlier*

⚠ Only in case you have the 4-screw Nextruder, you also need:

◆ Socket set screw M3x25 (1x)

## STEP 10 Installing the new PG-case



⚠ In case you have the 4 screw version of the nextruder:

◆ Install the set screw into the marked opening, running through the ring gear and the idler. Tighten it up fully.

◆ Place the new PG-case onto the gearbox.

◆ Secure it with three M3x25 screws. **Do not tighten them completely at this moment.**

ⓘ The screws on the PG-case will be completely tightened during the self-test in the final chapter.

## STEP 11 Assembling the Nextruder: parts preparation



◆ For the following steps, please prepare:

- ◆ MK4S fan holder (1x)
- ◆ Heatsink spacer (1x)
- ◆ M3x12 screw (3x)

⚠ Do not reuse the M3x10 screws you removed earlier. Due to the new parts, longer M3x12 screws are now required.

## STEP 12 Assembling the Nextruder



- ◆ From the front side of the Nextruder (side with the printer logo pg-case), insert three M3x12 screws in the heatsink.
- ◆ From the opposite side of the Nextruder, fit the heatsink spacer onto the three screws.
  - ◆ Make sure the protrusion protrudes towards you (like the screws).
- ◆ From the extruder motor side of the heatsink, attach the MK4S fan holder to the heatsink.

⚠ Avoid pinching the NTC thermistor cable. Guide it through the cutout as shown in the detail.

## STEP 13 Attaching the Nextruder

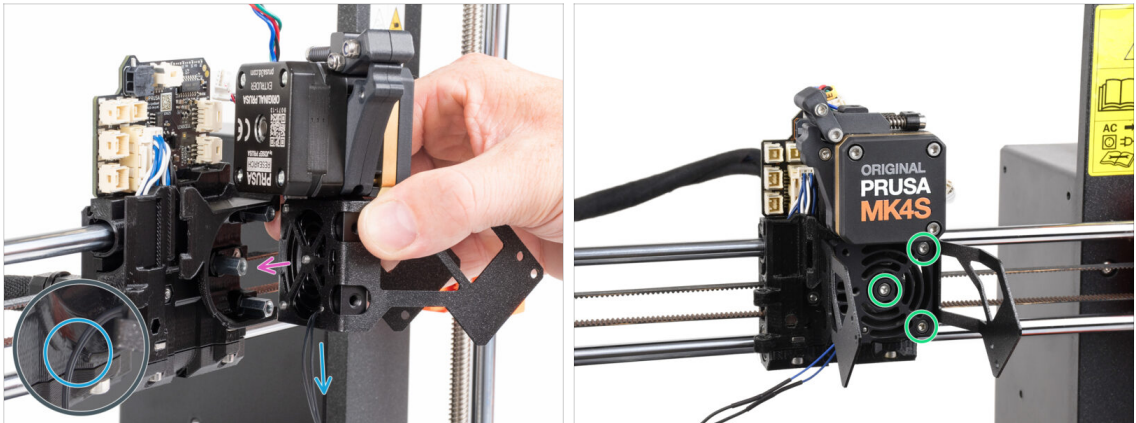

- Place the Nextruder assembly onto the spacers on the X-carriage. Line up the three screws with the three spacers.
- There is a cutout in the plastic part. **Guide the thermistor cable through this cutout.**
- ⚠ DO NOT PINCH ANY OF THE CABLES!**
- Align the heatsink screws with the spacers on the X-carriage and join both parts together by tightening them. Start with the middle one.

## STEP 14 Connecting the NTC thermistor

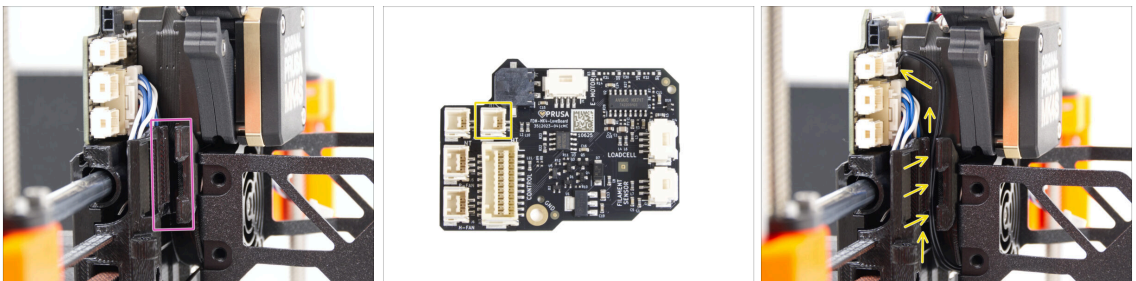

- Locate the cable channel on the left side of the X-carriage. We will guide some of the cables through this channel in the following steps
- Guide the NTC thermistor through the cable channel in the X-carriage up to the LoveBoard slot.

## STEP 15 Assembling the hotend fan: parts preparation



- ◆ For the following steps, please prepare:
- ◆ Hotend fan (1x) *you removed earlier*
- ◆ M3x18 screw (2x) *you removed earlier*

## STEP 16 Assembling the hotend fan

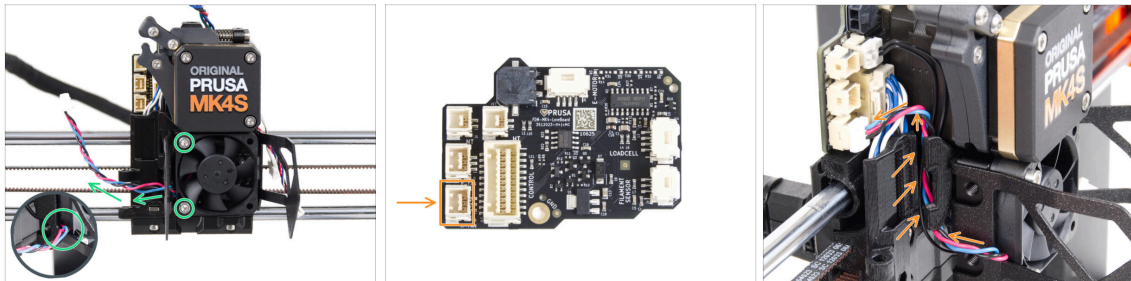

- ◆ Attach the hotend fan onto the heatsink with two M3x18 screws on the left side. **Tighten the screw gently, but firmly**, otherwise the plastic housing may crack. The cable must be pointing towards the lower-left corner.
- ⚠ There is a sticker on the hotend fan, the sticker must be on the rear side of the fan - not visible.
- ◆ Guide the fan cable through the cutout in the fan holder.
- ◆ Guide the fan cable between the thumb screws under the cable channel up and connect it to the **lower slot** on the LoveBoard.

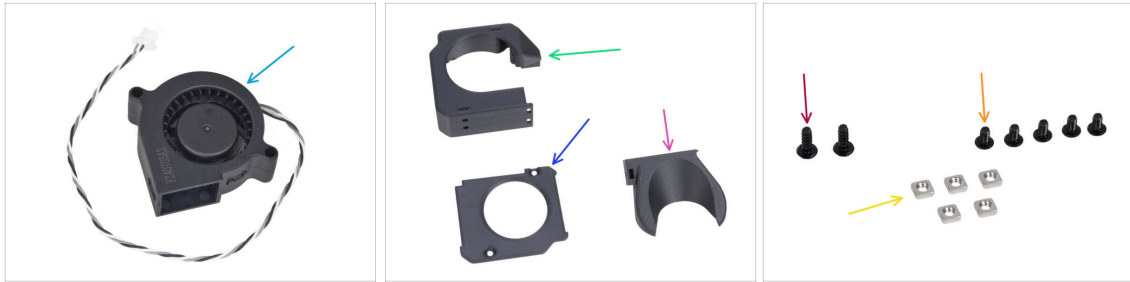
**STEP 17** Print fan blower: parts preparation

● For the following steps, please prepare:

- MK4S Print fan blower (1x)
- Fan-case (1x)
- Fan-case-cover (1x)
- Fan-shroud (1x)
- 3x8sT screw (2x)
- M3x5rT screw (5x)
- M3nS nut (5x)

**STEP 18** Assembling the print fan case

- From the flat surface of the Fan-case, insert two M3nS nut all the way into the holes.
  - **Double-check** from the side that the inserted nut is aligned with the hole in the part.
- From the opposite side, insert two M3x5rT nuts all the way into the holes. Check that nuts are fully inserted.
- Insert one M3nS nut into the hole in the Fan-shroud.

**STEP 19** Assembling the print fan blower

- Insert the MK4S print fan blower into the print fan blower case.
  - Guide the print fan blower cable through the cable channel in the Fan-case.
  - Close the fan with Fan-case-cover.
  - Secure the cover with two 3x8sT screws.
- ⓘ The screws cut thread directly into the plastic, so there might be some resistance.

**STEP 20** Assembling the fan shroud

- ⓘ Attach the Fan-shroud to the print fan blower assembly. Notice two teeth on the fan shroud and two rectangular holes in the blower assembly.
- First, insert those teeth into the rectangular cutouts.
  - Close the Fan-shroud and secure it with the M3x5rT screw.
- ⚠ Use reasonable force to avoid breaking the parts.



## STEP 21 Mounting the print fan blower assembly

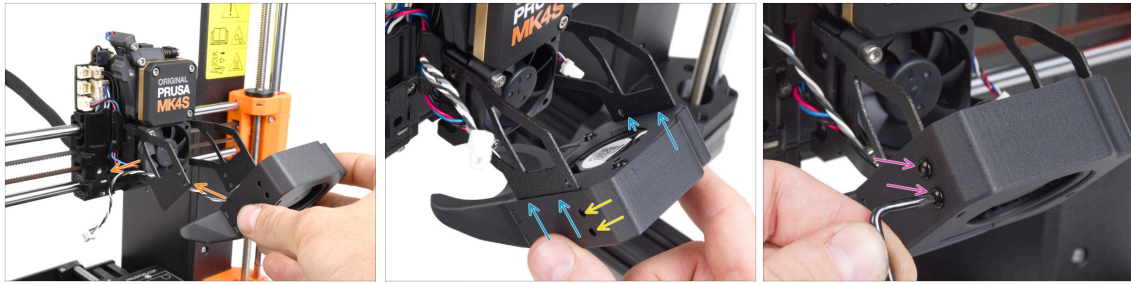

- ◆ Take the print fan blower assembly and guide the fan cable through the cutout on the left side of the fan holder.
- 📌 Use the same cutout through which the heatsink fan cable already guides.
- ◆ Attach the print fan blower assembly so that the metal forks of the fan holder engage into the printed part.
- ◆ Ensure that the holes of both parts are aligned.
- ◆ From the left side of the fan holder, secure both parts together using two M3x5rT screws.

## STEP 22 Connecting the print fan blower

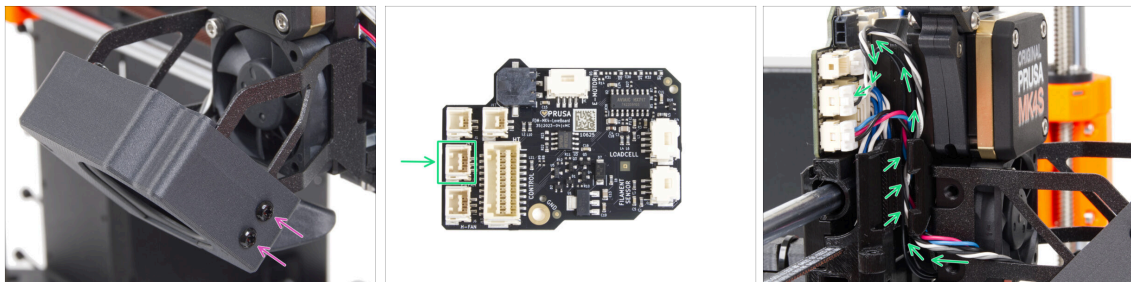

- ◆ From the right side of the fan holder, secure both parts together using two M3x5rT screws.
- ◆ Guide the print fan blower cable through the cable channel in the X-carriage and plug the connector to the middle slot on the LoveBoard.

## STEP 23 Prusa Nozzle info

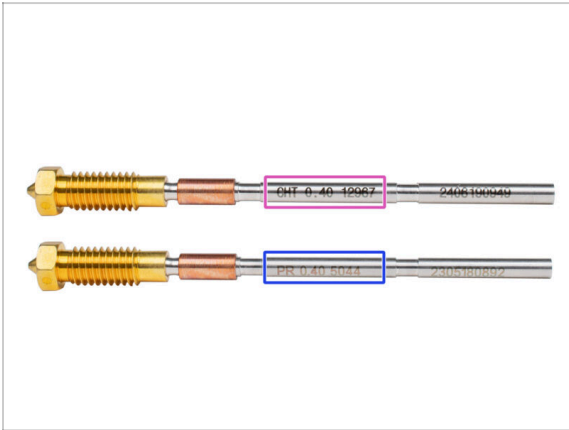

**⚠** There are two variants of the Prusa Nozzle that we ship with the printers:

- ◆ Prusa Nozzle brass CHT high flow (marked CHT)
- ◆ Prusa Nozzle brass (marked PR)
- ◆ For an **MK4S**, the Prusa Nozzle CHT is usually a default option. However, when using the **MMU3**, we recommend to continue using **the standard Prusa Nozzle** for optimal performance.
- ⓘ While it is possible to print with the Prusa Nozzle CHT, please note that specific settings are required to achieve high-quality multi-color prints.
- ◆ To replace the nozzle on the MK4S/MK3.9, please follow the instructions provided in the dedicated manual [How to replace the Prusa Nozzle \(MK4S/MK3.9S\)](#).

## STEP 24 Inserting the hotend assembly: parts preparation

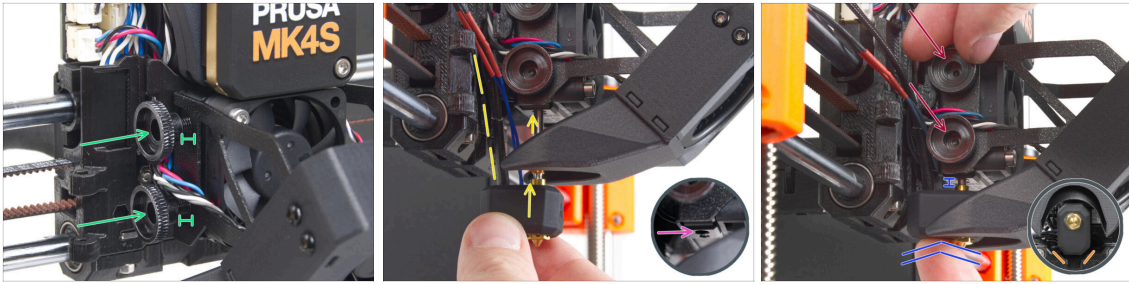

- ◆ For the following steps, please prepare:
- ◆ Hotend assembly (1x) *you removed earlier*
- ◆ Thumb screw (2x) *you removed earlier*

**STEP 25** Inserting the hotend assembly

- ◆ Insert two thumb screws into the heatsink. **Do not tighten them completely.** Two turns are enough for now.
- ◆ Look closely at the underside of the heatsink and find the hole for the hotend assembly.
- ◆ Insert the hotend assembly tube in the hole and slide the whole thing into the heatsink.
- ◆ Push the hotend assembly all the way into the heatsink. There should be approximately a 2 mm gap between the heatsink and the brass part of the nozzle.
- ◆ While pushing the hotend assembly in, **firmly tighten both thumb screws.**
  - ⚠ **Avoid pinching any cable between the screws and the heatsink!**
- ◆ From the underside, check that the hotend is oriented correctly. It must fit between the cutouts in the X-carriage.

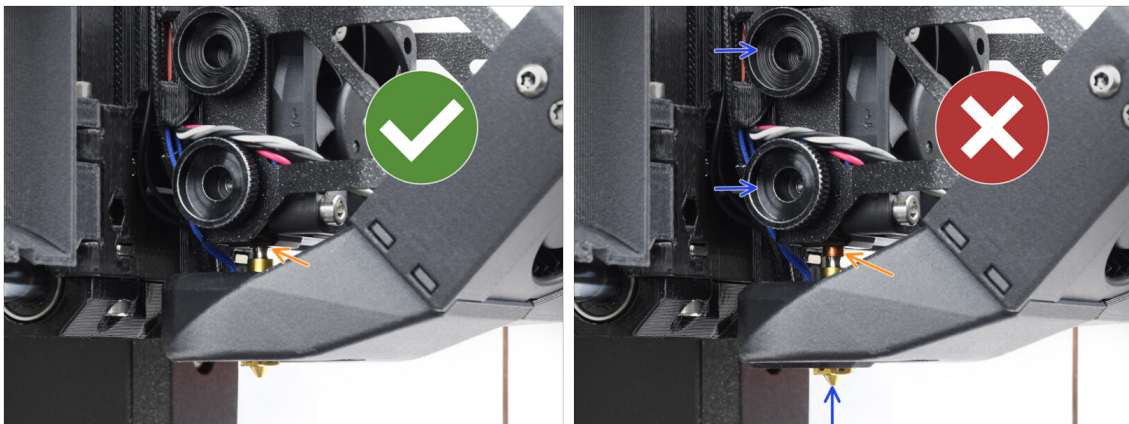
**STEP 26** Nozzle insertion check

- ◆ Verify that the nozzle is fully inserted. The copper ring on the nozzle should not be visible if it's properly seated.
- ⓘ If not fully inserted, poor heat transfer may occur, potentially leading to issues like nozzle clogs.
- ◆ To adjust the nozzle position, loosen the thumbscrews, reposition the nozzle, and then retighten the screws, while pushing the hotend assembly up.

## STEP 27 Connecting the hotend cables

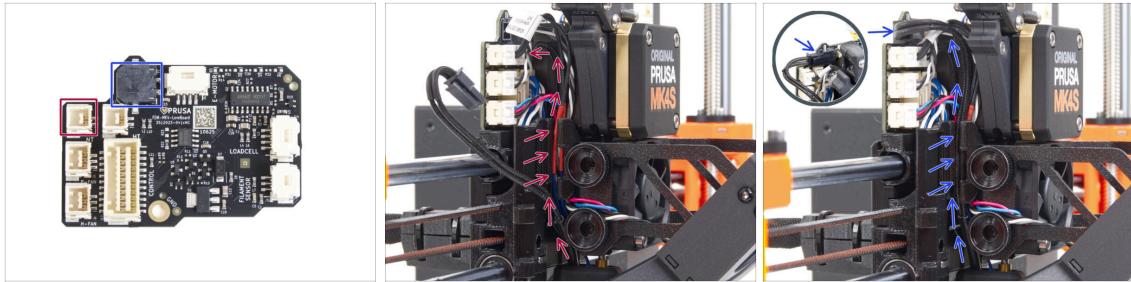

- ◆ Guide the hotend thermistor through the cable channel in the X-carriage and connect it to the LoveBoard.
- ◆ Guide the hotend heater through the cable channel in the X-carriage and connect it to the LoveBoard.

## STEP 28 Fan door cover: parts preparation

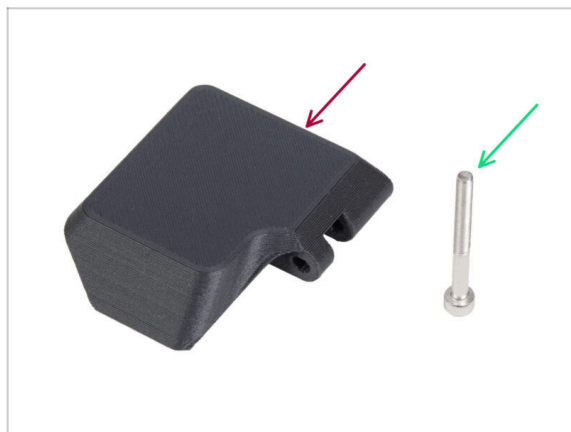

- ◆ **For the following steps, please prepare:**
- ◆ Fan-door-cover (1x)
- ◆ M3x30 screw (1x) *you removed earlier*

## STEP 29 Attaching the Fan-door-cover

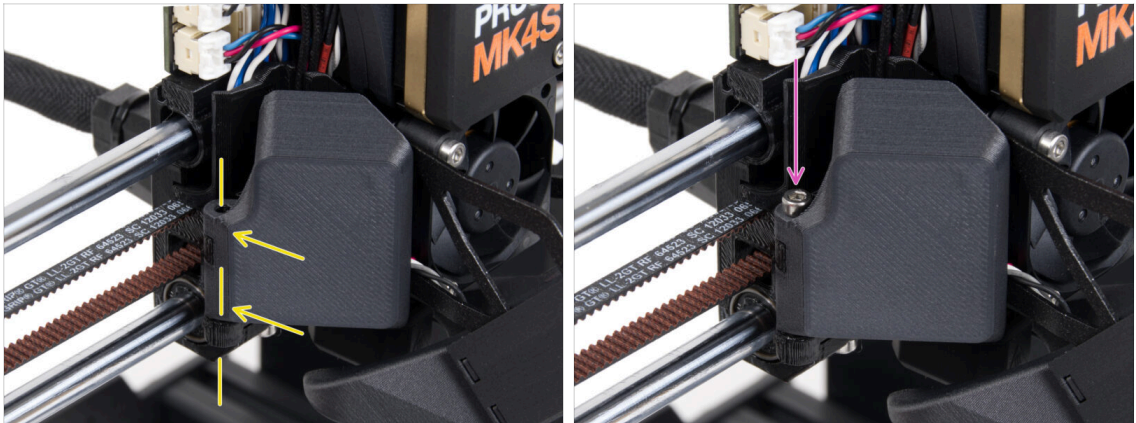

- Attach the Fan-door-cover hinge to its counterpart in the X-carriage. Holes in both parts must be aligned.
- Insert the M3x30 screw in the hinge on the fan-door. Fully tighten the screw, then loosen it by a quarter turn. **The fan-door must move freely!**

## STEP 30 Connecting the extruder cables



- Connect the Extruder motor cable to the connector on the top side of the LoveBoard.
- Connect the Loadcell cable coming from the right of the heatsink to the upper slot on the right side of the LoveBoard.
- Connect the filament sensor cable to the lower slot on the right side of the LoveBoard.

## STEP 31 LoveBoard: Wiring check

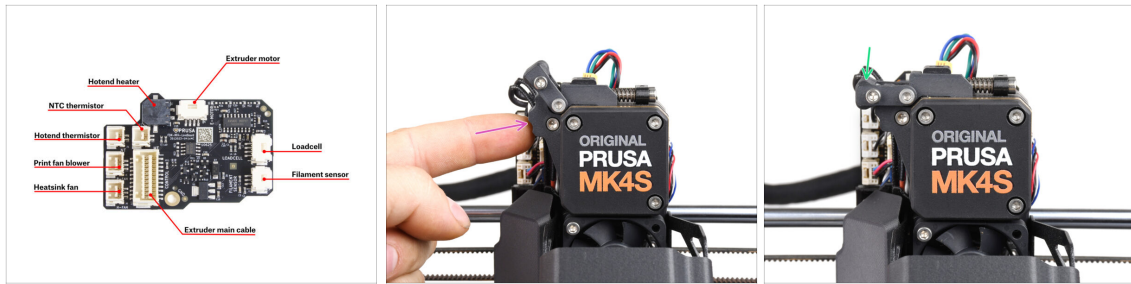

**⚠ Before covering the electronics, check the connection of all cables. Click on high-resolution preview in the top left corner.**

**⬛ Close the idler mechanism before proceeding to the next step if you haven't already done so. Use the following sequence:**

- Close the extruder idler to the extruder
- Close the idler-swivel and lock it over the extruder idler assembly

## STEP 32 Covering the LoveBoard: parts preparation

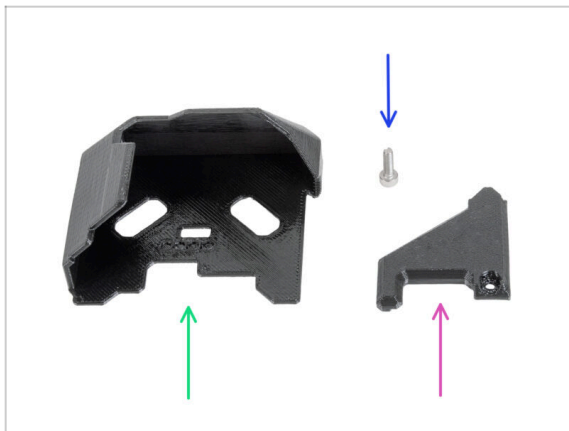

- ⬛ For the following steps, please prepare:**
- LoveBoard-cover (1x) *new part*
  - LoveBoard-cover-right (1x) *new part*
  - M3x10 screw (1x) *you removed earlier*

### STEP 33 Covering the LoveBoard: side cover

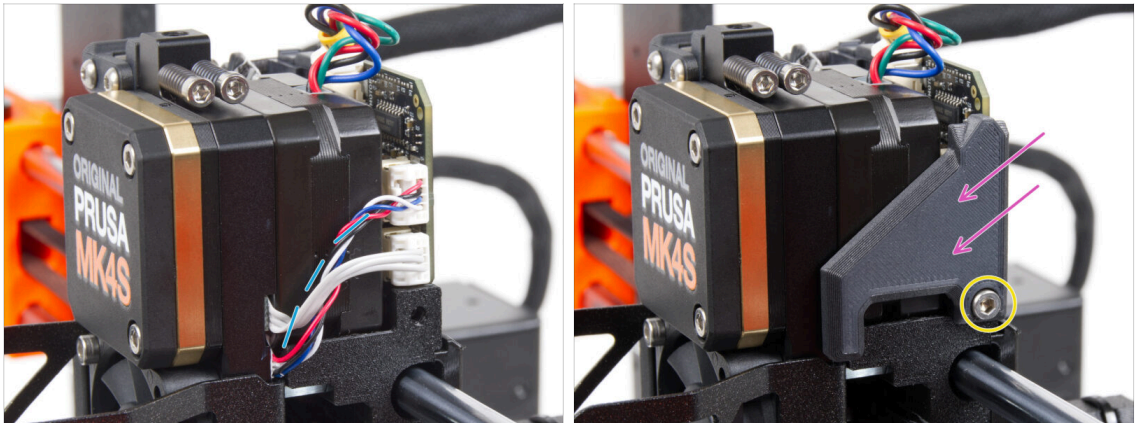

- Curve and arrange the cables on the right side of the extruder as you can see in the picture.
- Cover the cables with the LoveBoard-cover-right.
  - ⚠ **Do not pinch the cables!**
- Secure it with the M3x10 screw.
  - ⚠ **Make sure the LoveBoard-cover-right fits snugly against the right side of the extruder.** If not, it may cause the X-axis test to fail during the self-test because it will prevent the X-carriage assembly from moving all the way to the right.

### STEP 34 Covering the LoveBoard: top cover



- Push all cables to the extruder to make more space around them. See the picture.
- Slide the Loveboard-cover on the extruder. And push it all the way down. The cover must go behind the X-carriage-back.
  - ⚠ **Be careful not to pinch any cables.**
- Ensure that the two plastic covers fit together perfectly.

### STEP 35 The Nextruder is upgraded!



◆ That was tough, but you made it!

### STEP 36 Attaching the MMU3 unit

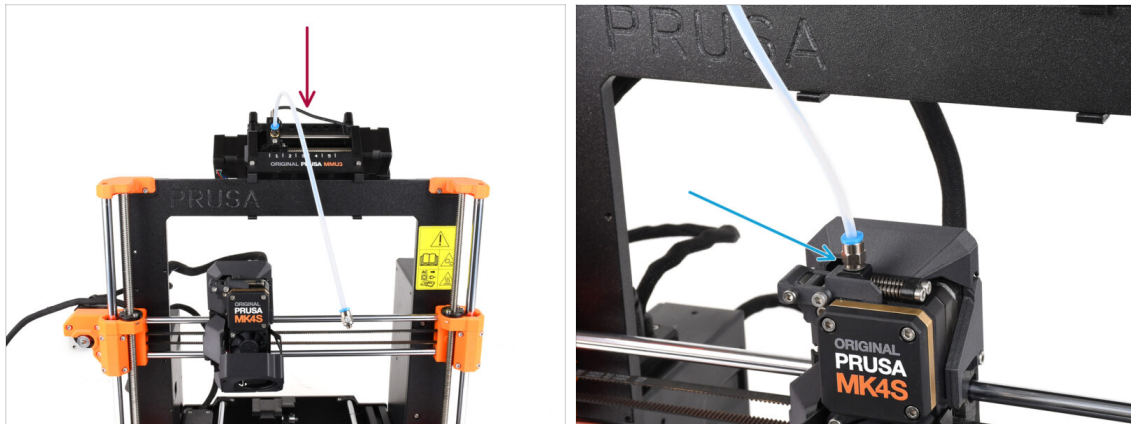

- ◆ Take the MMU3 unit and attach it onto the middle of the frame.
- ◆ Attach the PTFE tube fitting into the Nextruder.



### STEP 37 Connecting the MMU3 unit

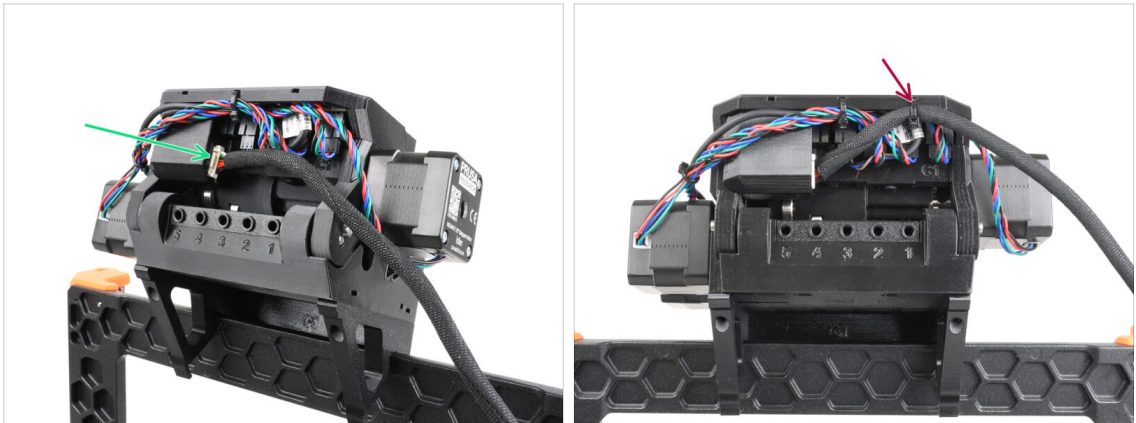

- On the back of the unit, connect the MMU-Printer cable.
- Using a zip-tie, attach the cable in the marked position.

### STEP 38 Haribo Zeit!



- Now you feel like you can fix anything, right? :)
- Eat two gummy bears.
- We're almost there. Let's continue with chapter 5. **Upgrading the connectivity.**

## 5. Upgrading the connectivity



## STEP 1 Tools necessary for this chapter

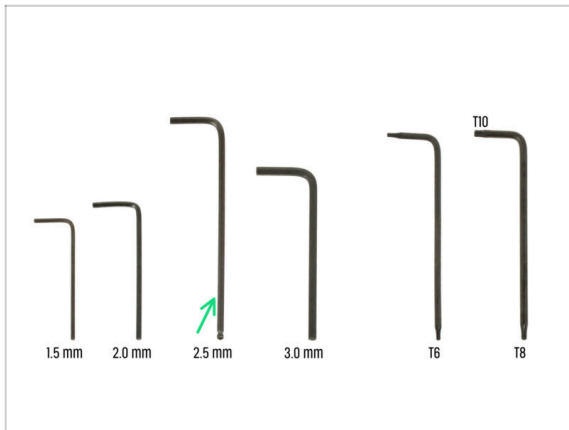

- ◆ For this chapter, please prepare:
- ◆ 2.5mm Allen key

## STEP 2 Opening the electronics

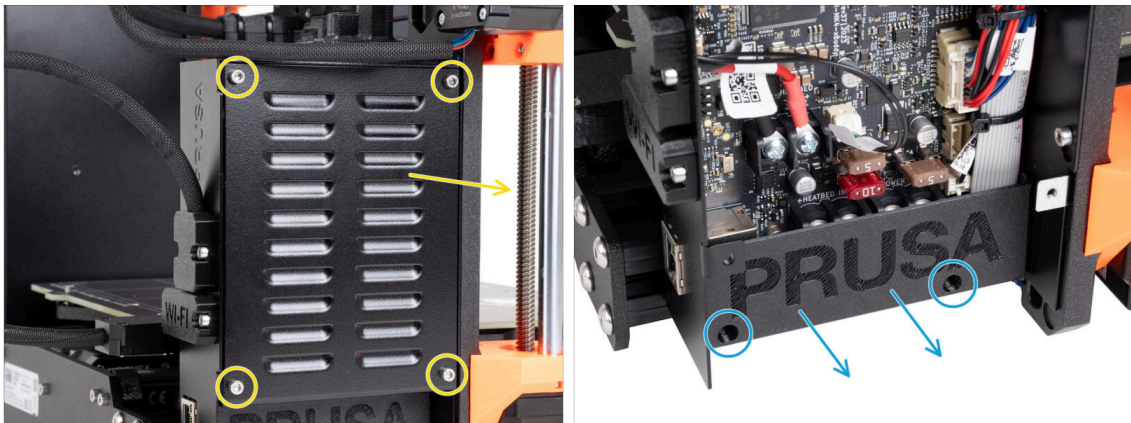

- ◆ Release four M3x6 screws and remove the xBuddybox-cover.
- ◆ Release two M3x10 screws from the EI-box-cover and remove the cover from the printer.
- ⓘ You will no longer need the EI-box-cover (plastic cover).

### STEP 3 Removing the Wi-Fi&heatbed covers



- ◆ Release two M3x6 screws from the Heatbed-cable-holder and remove it from the printer.
- ◆ Release the M3x6 screw from the Wifi-cover and remove it from the printer.
- ⓘ You will no longer need these printed parts.
- ◆ Gently remove the ESP-01S Wi-Fi module from the printer by pulling it out of the connector.
- ⓘ Even if you no longer need this part for your printer upgrade, keep it for future projects. For example, if you own an Original Prusa MINI/+, you can install this Wi-Fi module to take advantage of the benefits of connectivity on that printer as well.
- ◆ More information at [help.prusa3d.com](https://help.prusa3d.com).

### STEP 4 Wi-Fi: parts preparation

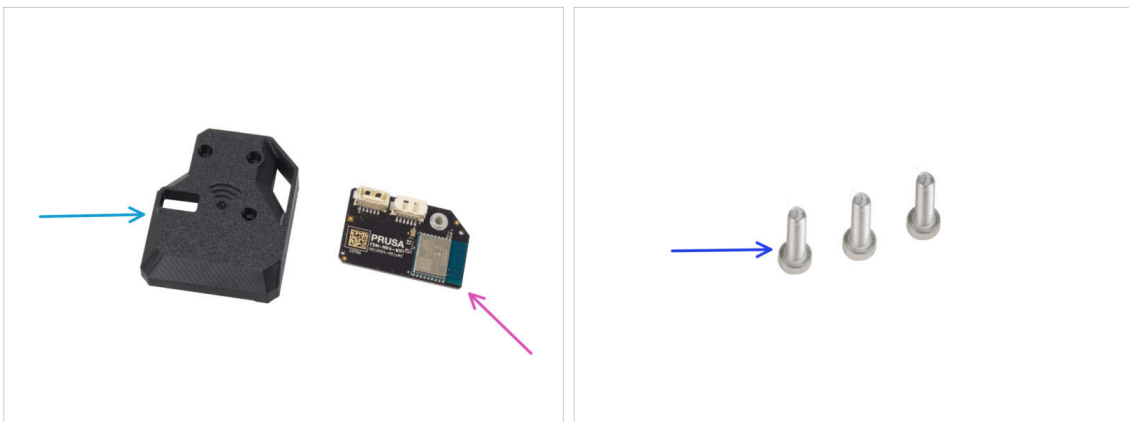

- ◆ **For the following steps, please prepare:**
- ◆ MK4S-Wifi-cover (1x)
- ◆ ESP-WiFi (1x)
- ◆ M3x12 screw (3x)

## STEP 5 Assembling the Wi-Fi



- Insert the ESP-WiFi module into the WiFi-cover, positioning it just below the bridge on the left side.
- On the other side, ensure the connector fits correctly into the hole in the cover.

## STEP 6 Installing the WiFi cover assembly

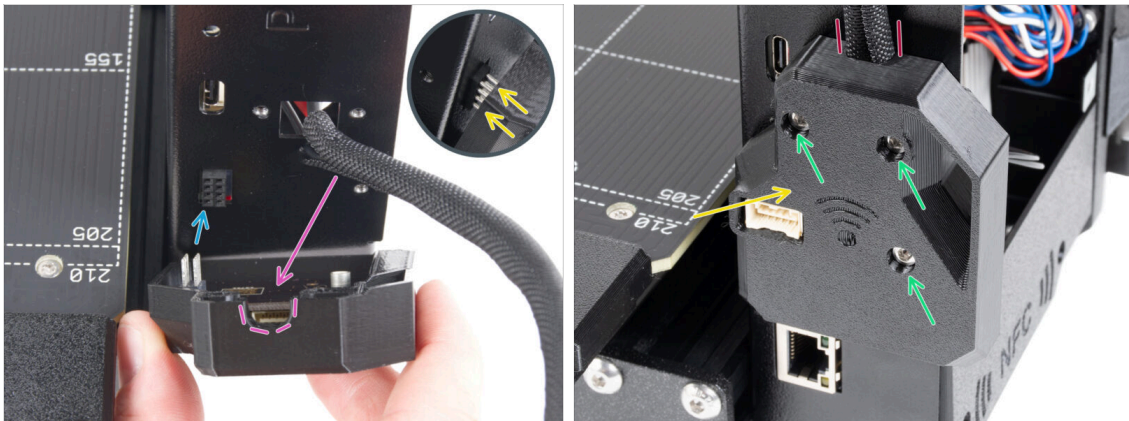

- ⚠ **Be very careful when handling and connecting the ESP module to avoid bending and damaging the pins.**
- Take the WiFi cover assembly and connect the ESP module pins to the connector in the xBuddy.
- Position the heatbed cable bundle into the cutout in the WiFi cover.
- Close the WiFi cover carefully, ensuring the pins of the ESP module are properly engaged in the connector on the xBuddy.
- ⚠ **Double-check that the heatbed cable bundle is in place.**
- Secure the cover with three M3x12 screws.

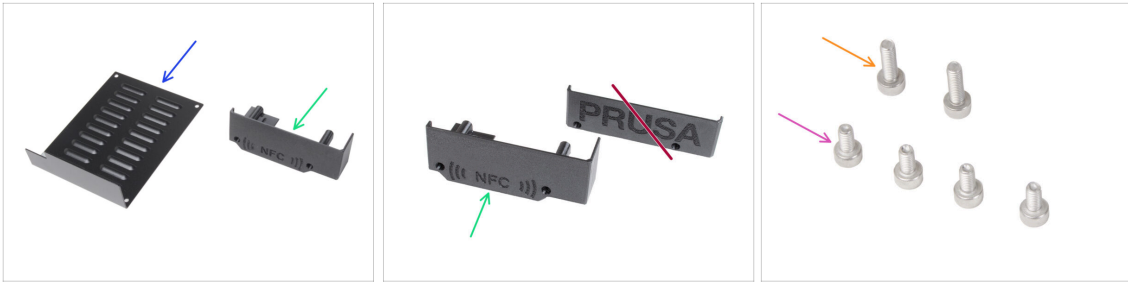
**STEP 7** NFC antenna: parts preparation I.

◆ **For the following steps, please prepare:**

◆ xBuddybox-cover (1x) *you removed earlier*

◆ El-box-cover (1x) *new part*

⚠ **Make sure you really have the new part ready. Compare according to the second picture.**

◆ M3x6 screw (4x) *you removed earlier*

◆ M3x10 screw (2x) *you removed earlier*

ⓘ The list continues in the next step ...

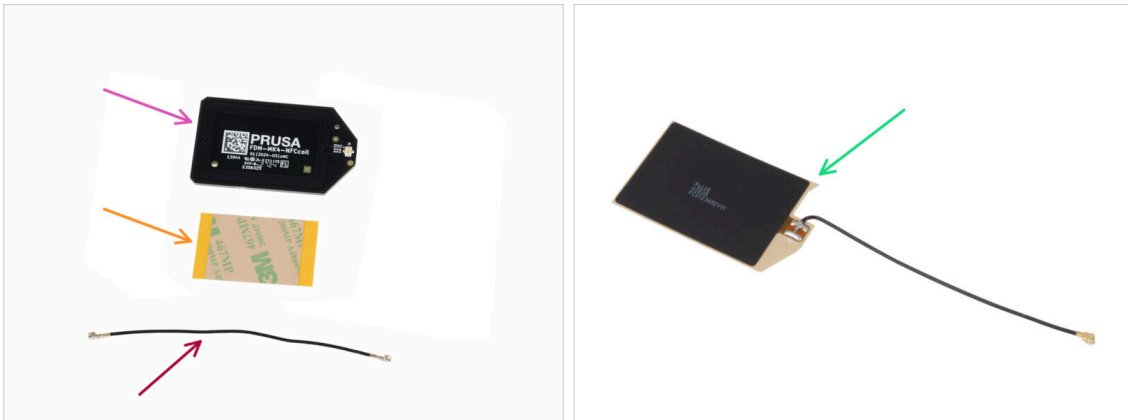
**STEP 8** NFC antenna: parts preparation II.

◆ NFCcoil (1x)

◆ Adhesive film 32 x 25 mm (1x)

◆ NFC coil cable (1x)

⚠ **Starting December 2024, packages may include another version of the NFCcoil with a different assembly process. Check your version and follow the correct steps.**

◆ NFCcoil assembly (1x)

ⓘ This NFCcoil version is pre-assembled, with the antenna cable and adhesive layer attached to the NFCcoil.

◆ If you have the pre-assembled version, proceed to the next step; otherwise, go to **Connecting the NFC antenna**.

## STEP 9 Installing the NFCcoil (pre-assembled)

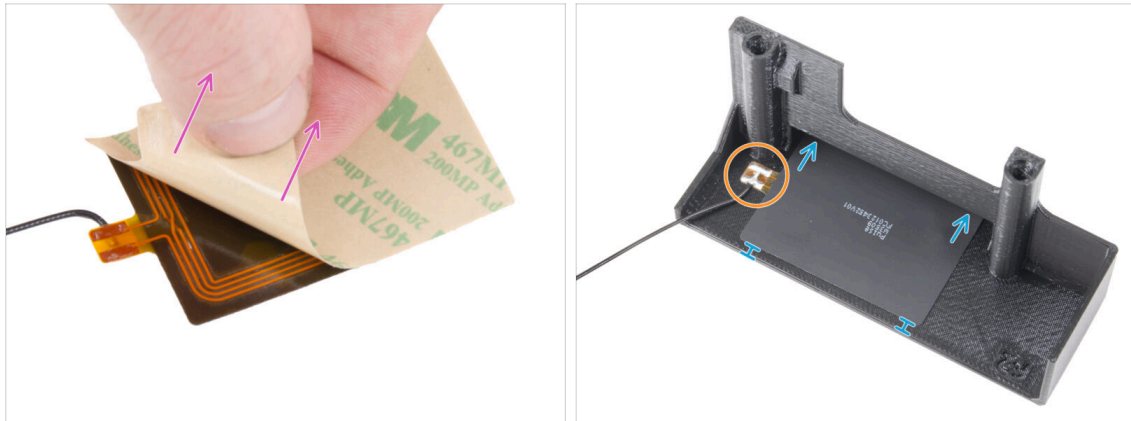

- ◆ Peel of the protective layer layer from the NFCcoil.
- ⚠ **CAUTION:** The NFCcoil surface is adhesive. Avoid sticking anything to it.
- ◆ Gently insert the NFCcoil into the part. And position correctly:
  - ◆ The antenna cable and the cable solder joint on the NFC coil board must be oriented as shown.
  - ◆ Stick the NFCcoil on the inner side of the EI-box-cover approximately like in the picture.

## STEP 10 Connecting the NFC antenna

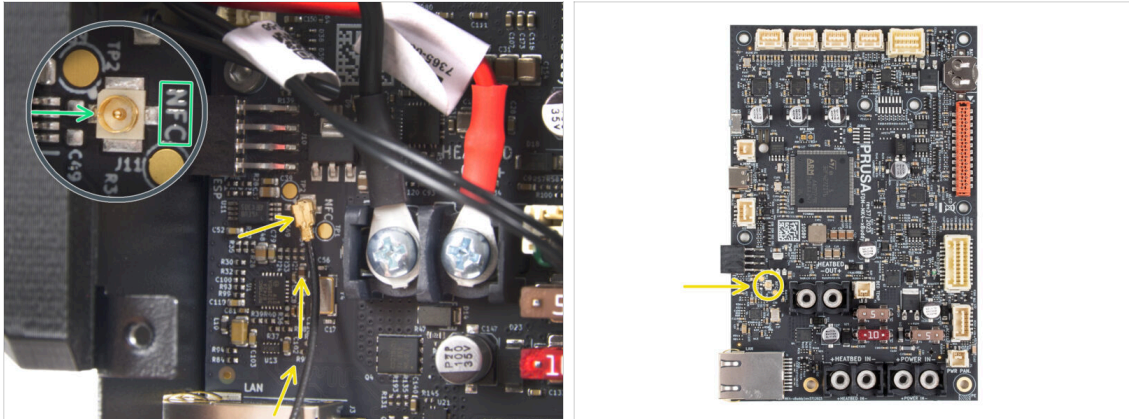

- ◆ Locate the small round connector labeled NFC on the bottom left side of the xBuddy board.
- ◆ Connect the NFC coil cable to the board by fitting the connectors together and pressing lightly until you feel a click, ensuring a correct connection.
- ⚠ **Ensure the NFC antenna cable connector is securely plugged in and does not come loose from the board.**
- ⚠ **BE EXTRA CAREFUL** when connecting the NFC antenna cable connector. Excessive pressure or misalignment can cause irreversible damage.
- ◆ Leave the other end of the cable free for now.
- ◆ If you connected the pre-assembled version, go to [Verify all connections once more!](#)

## STEP 11 Preparing the NFCcoil



- ◆ Peel off the yellow protective film from the adhesive tape.
- ⚠ **Avoid covering the holes in the NFCcoil board.**
- ◆ Stick the adhesive film on the cleaned side of the NFCcoil approximately as shown. The **side without the company logo**.
- ⚠ **Do not put the adhesive tape over any holes in the board!**



## STEP 12 Assembling the NFC antenna

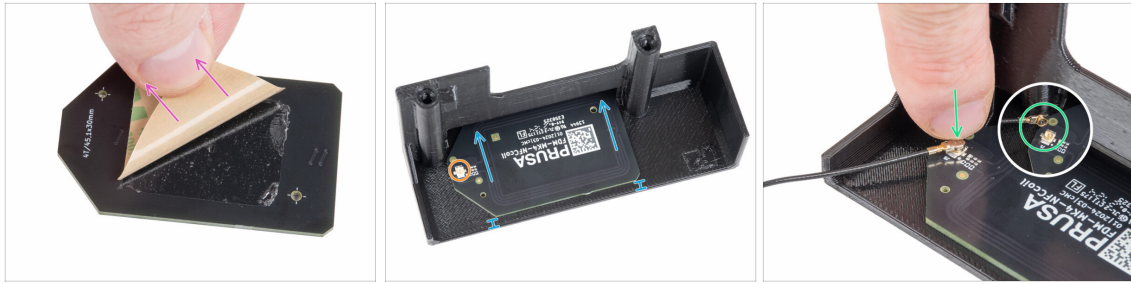

- ◆ Peel of the adhesive tape paper layer from the NFCcoil.
- ◆ Stick the NFCcoil on the inner side of the EI-box-cover approximately like in the picture. **See the correct orientation of both parts!**
  - ◆ Leave at least 2mm space between the NFCcoil end the edge of the EI-box-cover.
- ◆ Locate the small round connector on the NFCcoil.
- ◆ Connect the NFC coil cable to the board by fitting the connectors together and pressing lightly until you feel a click, ensuring a correct connection.
- ⚠ **Ensure the NFC antenna cable connector is securely plugged in and does not come loose from the board.**
- ⚠ **BE EXTRA CAREFUL** when connecting the NFC coil cable connector. Excessive pressure or misalignment can cause irreversible damage.

## STEP 13 Verify all connections once more!

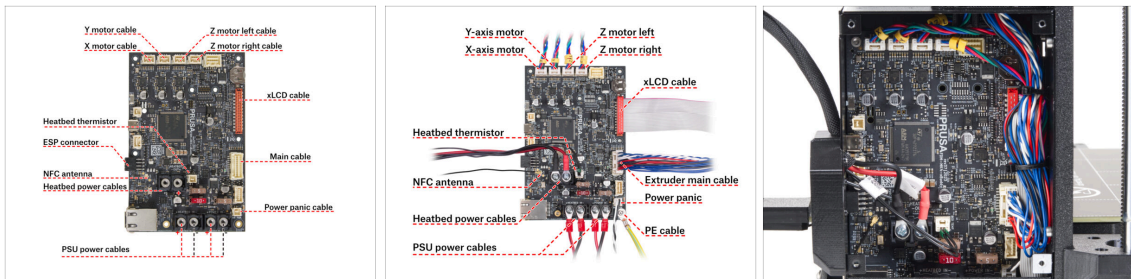

- ◆ Check your electronics connection with the first picture.
- ⚠ **Before covering the electronics, check and compare your wiring.**
- ◆ Compare your cable management with the third picture.
- ⓘ If you're upgrading from MK3.9, you may notice slightly different cable management due to motor cable adapters. These differences do not affect the instructions in this manual.
- ⚠ **Make sure that all connectors are fully inserted and PSU cables properly tightened. Otherwise, there is a risk of damage to the printer!**

## STEP 14 Covering the xBuddy box: bottom cover

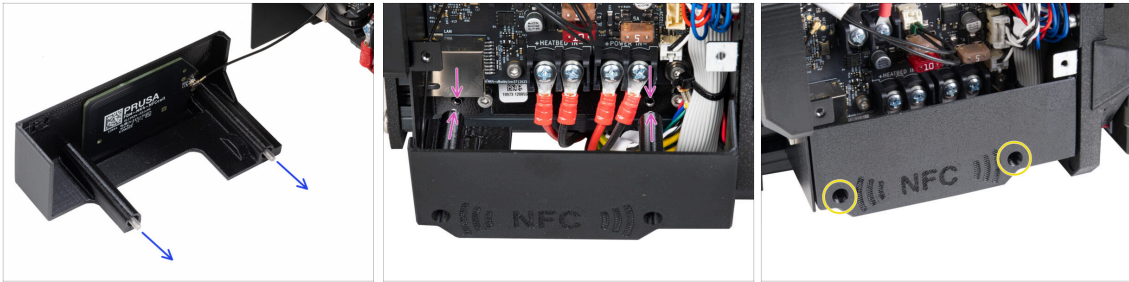

- ◆ Push two M3x10 screws through the EI-box-cover.
- ◆ Attach the cover to the xBuddy Box. There are two threaded holes in the xBuddy box. Make sure there is no cable in the way for the screws and the cover.
- ◆ Secure the el-box-cover by tightening both M3x10 screws to the xBuddy box.
- ⚠ **Be careful not to pinch the NFC cable** when closing the cover.

## STEP 15 Covering the xBuddy box



- ◆ Arrange the NFC coil cable to the rightmost side as shown.
- ⚠ **Avoid routing the cable over the Ethernet connector on the left and the power cables on the right, or it may get pinched and damaged when covering the electronics box.**
- ◆ Carefully cover the xBuddy box by first sliding the bent part of the cover into the box.
- ⚠ **Avoid pinching the cables. Double-check the NFC coil cable position.**
- ◆ Align the xBuddy box cover with the xBuddy box and secure it with four M3x6 screws.

## STEP 16 Serial number label: parts preparation



- For the following steps, please prepare:
- Serial number label (1x) *silver label*

## STEP 17 Sticking the serial number label



**⚠ This step is required in order to provide warranty! Don't throw the label away!**

- Remove the MK4 or MK3.9 label from the rear plate on the printer frame.
- Peel off the protective layer from the rear side of the label.
- Stick the label on the left side of the rear plate. Make sure, the surface is clean. Use the supplied cleaning pad.

## STEP 18 What's left...



● You will no longer need these parts:

● Old EI-box-cover (1x)

● Wifi-cover (1x)

● ESP-01S Wi-Fi module (1x)

ⓘ Even if you no longer need this part for your printer upgrade, keep it for future projects. For example, if you own an Original Prusa MINI/+, you can install this Wi-Fi module to take advantage of the benefits of connectivity on that printer as well.

● More information at [help.prusa3d.com](https://help.prusa3d.com).

● Heatbed-cable-holder (1x)

## STEP 19 Haribo time!



● That was easy!

● Eat two!

**STEP 20** That's it!



- ◆ **Congratulations!** You have just successfully upgraded your connectivity and thus completed your printer upgrade!
- ◆ But before you start printing, you need to do some selftests and activate some new features.
- ◆ Let's go to the final chapter 6. Preflight check.

## 6. Preflight check



## STEP 1 Attaching the print sheet

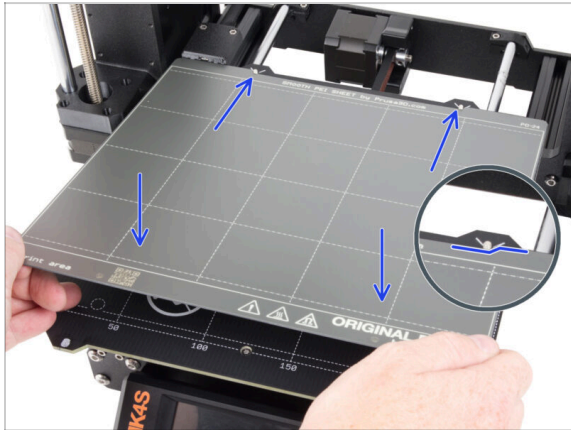

- ⚠ **Make sure there is nothing on the heatbed.** The heatbed must be clean. Any dirt can damage the surface of both the heatbed and the print sheet.
- 📌 **Attach the sheet by first aligning the rear cutout with the locking pins on the back of the heated bed** (marked in orange in the picture above). Hold the sheet by the front two corners and slowly lay it down onto the heated bed - **watch your fingers!**
  - 🛡 Keep the **print sheet** clean for optimum performance.
  - 🛡 #1 cause of prints detaching from the print surface is a greasy print sheet. **Use IPA (Isopropyl alcohol) to degrease it** if you have touched its surface before.
- 📄 We are using a print sheet with a smooth surface. However, the same procedure applies to other variants.

## STEP 2 Firmware updating

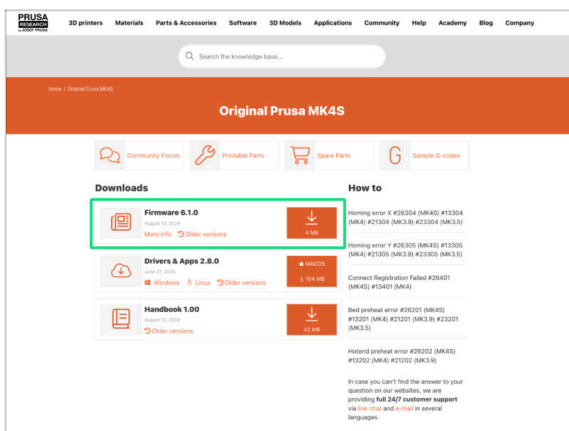

- 📌 On your computer, go to:
  - 📌 [prusa.io/mk4s](https://prusa.io/mk4s) to open the MK4S support page
  - 📌 [prusa.io/mk3-9s](https://prusa.io/mk3-9s) to open the MK3.9S support page
- 📌 There, you will always find the latest firmware, handbook, and PrusaSlicer for your printer.
- 📌 Download the latest firmware and save it to a USB drive.
- 📄 The firmware file has a .bbf extension.

### STEP 3 First run



- ◆ Insert the USB drive with the latest firmware into your printer.
- ◆ Connect the power cable and connect the printer into a wall outlet.
- ◆ Turn the printer on using the switch on the back.
- ⓘ The printer will now detect if a new firmware file is available on the USB drive.
- ◆ If the "New firmware available" screen appears, hit **FLASH** by pressing the rotary knob to upgrade to the latest firmware.
  - ◆ If no such message appears, the printer is running the latest firmware already. Proceed to the next step.

### STEP 4 Printer setup



- ◆ After upgrading to the newer firmware, navigate to *Settings* -> *Hardware*.
- ◆ On the following screen, select your printer type: MK4S or MK3.9S
- ◆ Leave the other items unchanged unless you have installed custom parts on the printer (e.g., nozzle with a different diameter, silicone sock removal).
- ◆ Go to *Settings* -> *Hardware* and check that the Nextruder Silicone Sock option is set correctly, depending on whether or not you have the Nextruder Silicone Sock installed on the hotend.



## STEP 5 Wizard - Selftest start



- Now, let's run a self-test to check the entire printer and ensure everything is plugged in and assembled correctly. The entire process takes a few minutes, with some parts requiring direct user interaction.
- ⚠ **NOTE:** While testing the axes, make sure that there is nothing in the printer obstructing the axes movement.
- ⚠ **WARNING:** Do not touch the printer during the self-test unless prompted! Some parts of the printer may be HOT and moving at high speed.
- The wizard starts with the fan check, Z-axis alignment and the X&Y axis test; all fully automatic.
- Go to *Control* -> *Calibrations & Tests* and select the first test in the list: Fan Test.
- ⓘ The printer remembers the results of each test from the last time the self-test was run. Thus, you can see all test items marked as completed. However, run the self-test again.
- After completing the fan test, you will be asked to end the self-test or continue with the remaining tests. Select Continue.

## STEP 6 Wizard - Loadcell Test



- ◆ The next step of the wizard will prompt you to touch the nozzle to test and calibrate the Loadcell. During this procedure, the parts of the printer are not heated up so that you can touch them. Click **Continue**.
- ◆ Do not touch the nozzle yet, wait until prompted by the **Tap nozzle NOW** message.
- ◆ Tap the nozzle from below. In case the Loadcell does not detect the touch, you will be prompted to repeat the step. Otherwise, you will see **Loadcell test passed OK** when it succeeds.

## STEP 7 Wizard - Gearbox Alignment



- ◆ Once you get to the Gearbox Alignment part, select **Continue** and follow the on-screen instructions.
- ◆ Undo the idler lock (swivel), then open the idler door.
- ◆ Loosen the three screws on the front of the gearbox by 1.5 turns.
- i The printer will go through the automatic gearbox alignment. This process can't be seen from the outside.
- ◆ Once prompted, tighten the three screws in the pattern indicated on the screen.

## STEP 8 Wizard - Filament Sensor Calibration



- 🟡 During the filament sensor calibration, you will need to use a short piece of filament. Prepare the filament and select **Continue**.
- 📄 There should be no filament inside the extruder before the calibration process starts.
- 🔴 Once prompted to, insert the filament end into the opening on top of the extruder.
- ⬛ Remove the filament after the calibration finishes.

## STEP 9 Haribo time!

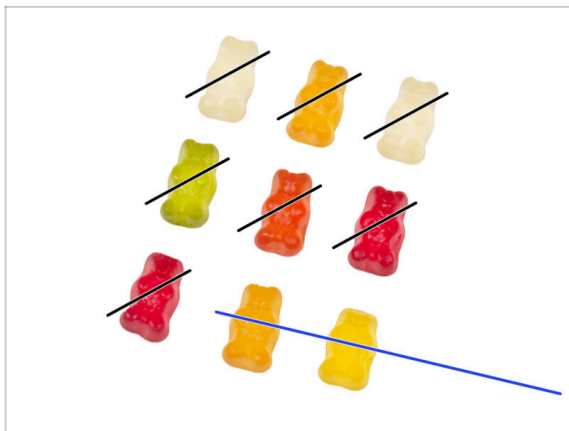

- 🟡 Congratulations to all those who patiently ate according to the instructions. **Eat the rest!**

## STEP 10 Loading a filament



- Place the spool holder back on the printer frame.
- Add a spool or a sample of your favorite filament onto either side of the spool holder.
- Guide the filament end through the filament guide into the extruder. Using the filament guide prevents filament tangling.
- Once a filament is detected, the printer will load it automatically. It is important to select the correct type of filament you are using on the screen. We recommend using **PLA** material for the first test print.
- The printer will purge some of the material through the nozzle. Confirm its color is clear by selecting **YES** on the screen and remove the leftover plastic from below the nozzle.

⚠️ Proceed carefully, the nozzle is now very **HOT!** Do not touch it with your bare hands!

## STEP 11 Printable 3D models

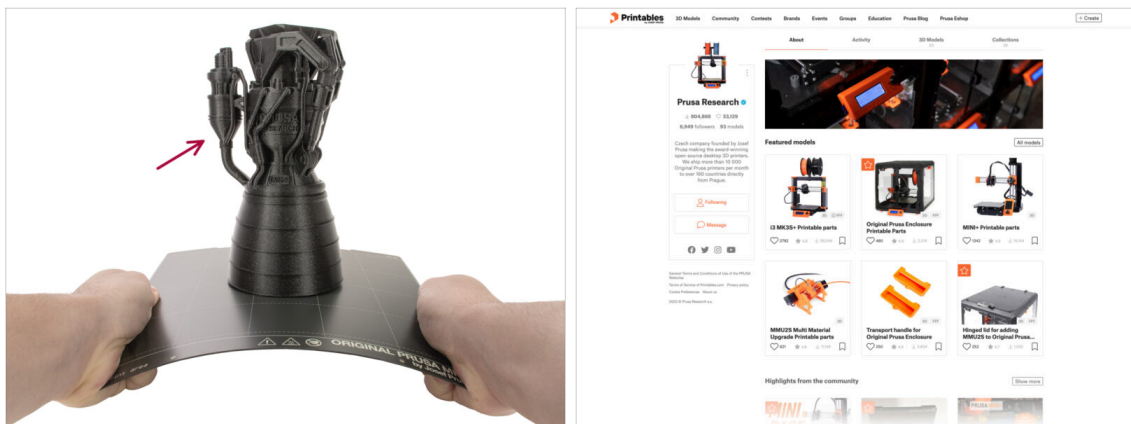

- **The printer is now ready to print!**
- You can start by printing some of our test objects from the bundled USB drive.
- The sample objects are also available on the official [Prusa Research Printables profile](#)

## STEP 12 Network setup: Prusa Connect (Optional)

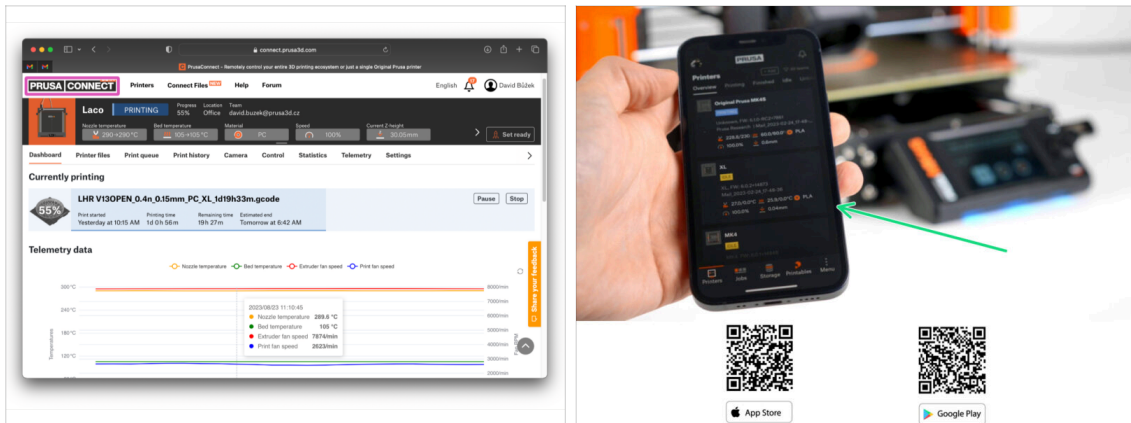

- ◆ Don't forget to add your printer to **Prusa Connect** to remotely control and monitor all your printers. However, it is optional and can be done at any time.
  - (i) For more informations read the article [Prusa Connect and PrusaLink explained](#).
- ◆ Use the official **Prusa mobile app** to add your printer to Prusa Connect, allowing you to manage it anytime via the app.
  - (i) For further details, check out the [Prusa Mobile App](#) article.
- ◆ If you need to connect your printer to a network, you have several options available.
  - (i) All available methods are outlined in the [Network Connection](#) article.

## STEP 13 PrusaSlicer

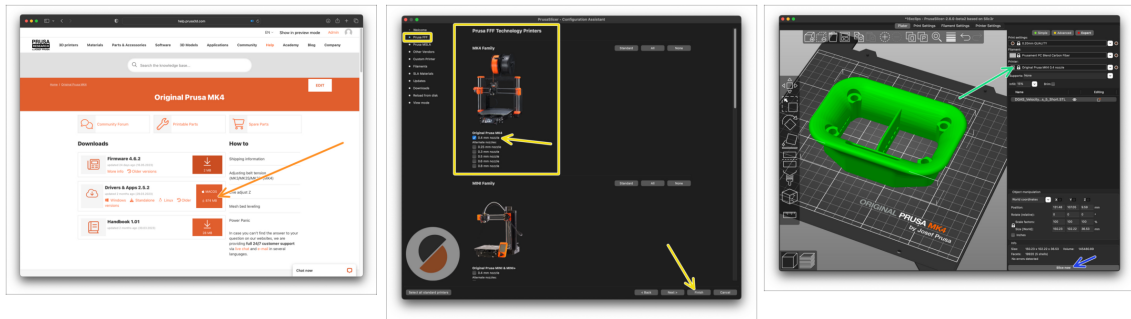

- ◆ Ready to print your own models?
- ◆ Visit [help.prusa3d.com](https://help.prusa3d.com) once again. Download and install the latest **Drivers & Apps** package onto your computer. This package includes the **PrusaSlicer** app.
- ◆ Open the **PrusaSlicer** app. If you're running it for the first time, Configuration Wizard will show up. Visit the Prusa FFF tab in the Wizard, select **Original Prusa MK4S** or **MK3.9S** in the **0.4mm nozzle** version (the default nozzle size) and hit **Finish** to start using the MK4S printer profile.
- ◆ Make sure the Original Prusa MK4S or MK3.9S is selected in the Printer menu on the right, when slicing for the MK4S/MK3.9S.
- ◆ **Import a model** of your choice into PrusaSlicer, adjust the settings if needed, hit **Slice** and export the G-code file onto the USB drive to print it on your MK4S/MK3.9S.

## STEP 14 Quick guide for your first prints



📖 Please read the 3D Printing **Handbook** dedicated to your printer and follow the instructions to set up and use the printer properly. The latest version is always available at [help.prusa3d.com](https://help.prusa3d.com).

⚠️ **Read the Disclaimer and Safety instructions chapters.**

## STEP 15 Prusa knowledge base

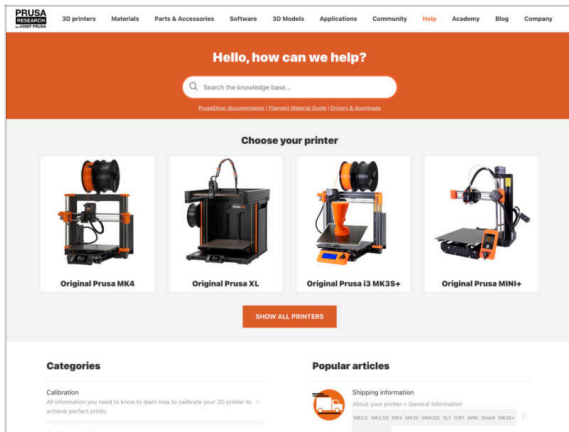

🛒 If you encounter any problems at all, don't forget you can always check out our knowledge base at [help.prusa3d.com](https://help.prusa3d.com)

🛒 We're adding new topics every day!

## STEP 16 Join Printables!

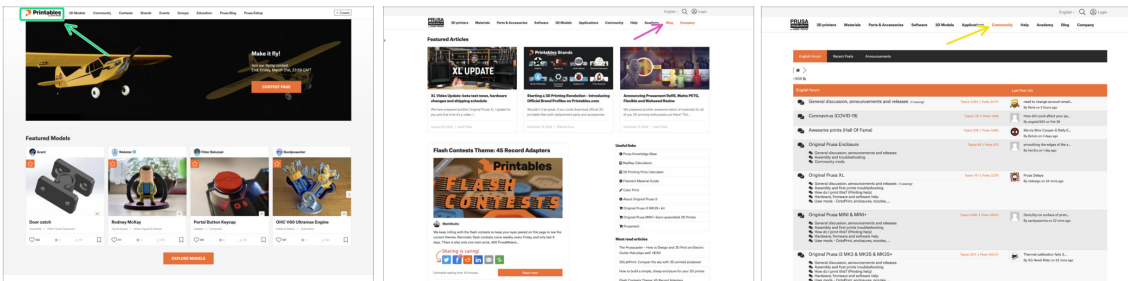

🌱 Don't forget to join the biggest Prusa community! Download the latest models in STL or G-code tailored for your printer. Register at [Printables.com](https://printables.com)

🌸 Looking for inspiration on new projects? Check our blog for weekly updates.

🟡 If you need help with the build, check out our forum with a great community :-)

📍 All Prusa services share one user account.

# Manual changelog

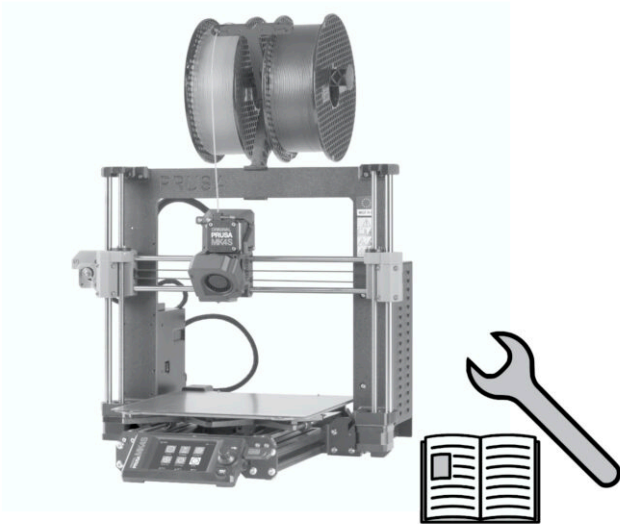



## STEP 1 Version history

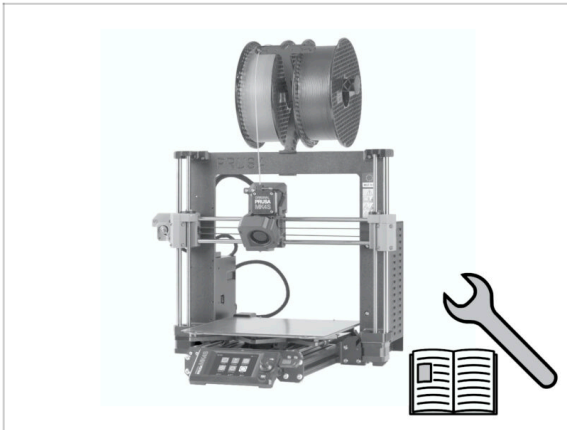

- **Versions of the MK4 to MK4S upgrade manual:**
- 08/2024 - Initial version 1.00
- 12/2024 - Updated to version 1.01

## STEP 2 Changes to the manual (1)

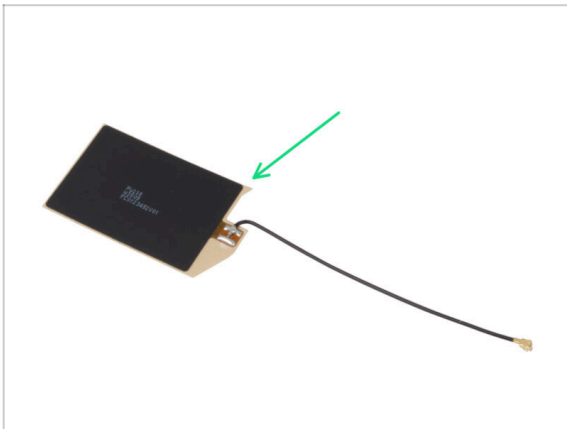

- 12/2024 - NFC antenna
  - New version of the NFC antenna.
  - Added instructions for a pre-assembled NFCcoil version included in kits starting December 2024.
- ⓘ Manual version 1.01













